



# Antilope, A Portable Low-Cost Sensor System for the Assessment of Indoor and Outdoor Air Pollution Exposure

Fabian Lenartz<sup>1\*</sup>, Marie Dury<sup>1</sup>, Benjamin Bergmans<sup>1</sup>, Virginie Hutsemékers<sup>2</sup>, Valéry Broun<sup>3</sup>, Christophe Brose<sup>3</sup> and Sylvain Guichaux<sup>3</sup>

<sup>1</sup>Air Quality Department, ISSeP, Liège, Belgium, <sup>2</sup>AwAC, Namur, Belgium, <sup>3</sup>Electronics Department, HEPL, Liège, Belgium

The increasing availability of low-cost sensors and open source projects make it easier than ever for a maker to build his own air quality node. Nonetheless, depending on one's goal and its related data quality objective, to customize an existing project or to build a specific printed circuit board may still be very useful. In the framework of the Outdoor and Indoor Exposure project, a portable mini-station has been developed, tested and then used in two experiments: exposure assessment and complementary network measurement. The present paper focuses on the description of the equipment that was designed and prototyped, as well as on the tests that were made in the lab and in the field to evaluate its overall performance and that of its different sensors. Finally, we present what we consider to be its main drawbacks and our perspectives for further development and tests.

## OPEN ACCESS

### Edited by:

Donatella Puglisi,  
Linköping University, Sweden

### Reviewed by:

Stanislav Moshkalev,  
State University of Campinas, Brazil  
Shekh Md Mahmudul Islam,  
University of Dhaka, Bangladesh

### \*Correspondence:

Fabian Lenartz  
f.lenartz@issep.be

### Specialty section:

This article was submitted to  
Sensor Devices,  
a section of the journal  
Frontiers in Sensors

Received: 12 March 2021

Accepted: 24 August 2021

Published: 08 September 2021

### Citation:

Lenartz F, Dury M, Bergmans B, Hutsemékers V, Broun V, Brose C and Guichaux S (2021) Antilope, A Portable Low-Cost Sensor System for the Assessment of Indoor and Outdoor Air Pollution Exposure. *Front. Sens.* 2:679908. doi: 10.3389/fsens.2021.679908

**Keywords:** electronics, design, air quality, low-cost sensor, versatility, personal exposure

## INTRODUCTION

When we wrote the OIE (Outdoor and Indoor Exposure) project proposal in 2016, we were aware of the existence of some commercial and prototype LCSS (low-cost sensor systems) but had only limited knowledge about their technologies and potential uses. Since that time, Baron and Saffell (2017) and Lewis et al. (2018) reviews have been published, offering a helpful resource for the atmospheric science community, agencies with direct interest in air pollution and greenhouse gases, sensor manufacturers, NGOs as well as citizens and community users.

We identified two main applications in the framework of our project: personal exposure assessment and complementary network measurement. Our searches for an existing LCSS to use in our project were not conclusive, we did not identify LCSS that could be used for both applications, displayed reasonable performance at a reasonable price, and were not complete black boxes. So, we decided to design, prototype and build our own system, using commercial sensors and breakouts. This approach allows us to master most of the measurement chain but requires more man power, mainly to perform data management and some maintenance operations. This approach also demands an initial financial investment. We consider to have recouped it after the production of the 35th device but this strongly depends on the structure of one's organization. Peltier et al. (2020) shows an example of costs linked to the use of low-cost sensors and Karagulian et al. (2019) a price comparison of various commercial sensors and LCSS.

The development of our device has been largely inspired by the works of Gerboles et al. (2015) and Gerboles et al. (2016) on the open data/software/hardware multi-sensor AirSenseEUR platform. Other relevant open source systems are now available, e.g. hackAIR home/mobile (see <https://hackair.eu>), airRohr (see <https://sensor.community> formerly luftdaten.info), EnviroMonitor (see

<https://enviromonitor.github.io>) and Eter (see <https://github.com/rlyehlab/eter-monitor>) just to cite a few of them. In terms of pollutants, these DIY projects focus on PM<sub>2.5</sub> because the optical technology is probably the most mature at this time. A great asset of these projects is the training of citizens and the raising of awareness about air pollution but they also propose interesting off-road developments, like the hackAIR cardboard or the web interface and the API of sensor. community. All these open source projects really help in making better LCSS.

In anticipation of the CEN TC264 WG42 technical specifications on the performance evaluation of air quality sensor systems for gaseous pollutants in ambient air and air quality sensors for PM in ambient air, several groups have established procedure for that purpose, e.g. Spinelle et al. (2013, 2015), Polidori et al. (2017), Fishbain et al. (2017) and the AIRLAB Microsensor Challenge (2021). In this paper, we just did basic side-by-side experiments. More thorough protocols of evaluation will be explored in the future. We also performed no elaborate calibrations, even if as pointed out by Baron and Saffell (2017), data analysis and validation will be of high importance to deliver reliable concentration readings. More and more articles focus on machine-learning to provide one with the best possible measurements, e.g. Spinelle et al. (2014) with ANN (Artificial Neural Network) or Mahajan and Kumar (2020) with Support Vector Regression. These techniques are very promising and yield substantial improvements. However, in order to keep track of what is measured and what is modeled, it seems to us that there is a rising agreement in the air quality community about the adoption of a unifying terminology for data processing levels, as proposed by Schneider et al. (2019); in this paper we consider level 0 and level 1 data.

Finally, we would like to mention the works of Mead et al. (2013), Castell et al. (2015) and Wesseling (2019) that show real-case and useful applications based on LCSS networks.

The paper is divided as follows: in *Materials and Methods* section, we present the hardware and software of our mini-station, in *Results* section, we display the preliminary results of a side-by-side exercise and a personal exposure assessment experiment and in *Discussion* section, we discuss the main drawbacks of our system and possible improvements.

## MATERIALS AND METHODS

### Hardware: Sensors and Electronics

The original specifications of our mini-station were as follows:

- portable device (dimensions  $\leq 15 \text{ cm} \times 10 \text{ cm} \times 5 \text{ cm}$  and weight  $\leq 500 \text{ g}$ );
- battery life of at least 2 h when operating;
- measurement of the following parameters within the specified range (when provided) and at a 1-min rate or faster:
  - Temperature ( $-10; 40$ ) °C;
  - Relative humidity (0; 100) %;
  - Location;

- Acceleration detection ( $\geq 3 \text{ g}$ )  $\text{ms}^{-2}$ ;
- NO (0; 1000) ppb approximately (0; 800)  $\mu\text{gm}^{-3}$ ;
- NO<sub>2</sub> (0; 1000) ppb approximately (0; 532)  $\mu\text{gm}^{-3}$ ;
- O<sub>3</sub> (0; 1000) ppb approximately (0; 500)  $\mu\text{gm}^{-3}$ ;
- PM<sub>2.5</sub> (0; 500)  $\mu\text{gm}^{-3}$ ;
- gas sensors based on the electrochemical technology;
- record of the measurements at a 1-s rate or faster in a CSV file;
- operatable on mains power.

These technical requirements were set to obtain a versatile device that could cover the typical indoor and outdoor concentration range for these pollutants, and be used both for stationary or itinerary applications, considering that one is rarely commuting more than 2 h.

Based on the requirements listed above, our partner HEPL (Haute École de la Province de Liège) chose to use:

- the Adafruit BME680 breakout for relative humidity, temperature and barometric pressure, which was chosen over the BME280 in the course of the project;
- the SparkFun GPS-12751 module breakout for location;
- the SparkFun MMA8452Q breakout for triple-axis acceleration;
- the Sensirion SPS30 sensor for PM<sub>1</sub>, PM<sub>2.5</sub>, PM<sub>4</sub> and PM<sub>10</sub> and the Honeywell HPM115S0 sensor for PM<sub>2.5</sub> and PM<sub>10</sub>;
- the Alphasense NO-A4, NO<sub>2</sub>-A43F and OX-A431 electrochemical sensors respectively for nitric oxide, nitrogen dioxide and ozone concentration (after subtracting NO<sub>2</sub>);
- the Texas Instrument LMP91000 Analog Front End (AFE), which is at the core of the “current to concentration” conversion for the considered gas sensors;
- the Microchip ATmega2560, which is an 8-bit microcontroller with, among others, a 16-channel 10-bit A/D converter (ADC) that achieves 16 MIPS at 16 MHz.

Both PM sensors are laser-based particle counters with a time response less than 10 s. We are not aware of a PM low-cost sensor based on another functioning principle than light scattering. The latter allows one to determine 1) the particle number concentration by counting the pulses of scattered light reaching the detector, 2) their size, which depends on the intensity of scattered light and 3) their shape, which depends on the spatial pattern of scattered light. The last two properties are usually only roughly estimated by PM low-cost sensors and remain the prerogative of higher end instruments. The particle diameter range goes typically from 300 nm to 10  $\mu\text{m}$  and the number concentration range from 0 to 10<sup>6</sup> particles/L. The Antilope can work either with the HPM115S0 or the SPS30 sensor.

For the considered gases (NO, NO<sub>2</sub> and O<sub>3</sub>) we wanted electrochemical rather than metal oxide sensors for they have a lower power consumption, typically 2 mW against 500 mW, they display a better selectivity and they are more stable; their

biggest disadvantage is their life expectancy, typically 18 months against more than 10 years, and they are somewhat more expensive (Romain 2018). The working principle of the electrochemical gas sensors is an oxidation-reduction reaction that takes place at the working and counter electrodes of the sensor, which produces a limited current that is proportional to the concentration of the detected gas (Chou, 1999; Yi et al., 2015). For example, a NO<sub>2</sub> sensor might be the siege of the following reactions:

$NO_2 + 2H^+ + 2e^- \rightleftharpoons NO + H_2O$  (reduction at the working electrode  $E = +1.15$  V).

$1/2 O_2 + 2H^+ + 2e^- \rightleftharpoons H_2O$  (oxidation at the counter electrode  $E = +1.25$  V).

$NO_2 \rightleftharpoons NO + 1/2 O_2$  (overall reaction  $E = -0.10$  V).

These equations were drawn from the Alphasense Application Note 107-06 (2009).

For common air quality applications, i.e. not in specific industrial environments, it would also be interesting to monitor NH<sub>3</sub> and VOCs, the first for its role in acidification, eutrophication and secondary particle formation, the latter because some of these species are carcinogenic, e.g. benzene, formaldehyde, and some of these species also play a role in new particle formation, e.g. isoprene,  $\alpha$ -pinene.

For the Antilope all selected electrochemical sensors work in the (0; 20) ppm range with a warranty of performance. Each of them is delivered with its intrinsic sensitivity, zero current, auxiliary zero current and time response values. The sensitivity (or gain) is the factor that transforms pollutant concentrations into variations of the output current, it is expressed in nAppm<sup>-1</sup>. The zero current (or offset) is the non-zero output current response in a pollutant-depleted environment, it is expressed in nA; the auxiliary zero current is basically the same but relates to the auxiliary electrode. Although this information is provided by the manufacturer on the basis of his calibration tests, field tests may highlight the necessity of adapting these parameters. Regarding the time response, all sensors received so far displayed a value less than 30 s.

Another important thing to keep in mind when working with electrochemical sensors is the necessity of maintaining a specific bias voltage between the working and the reference electrodes, e.g. +200 mV for the NO sensor, and 0 mV for the NO<sub>2</sub> and O<sub>3</sub> sensors. This bias voltage should be maintained even when the system is off, at the risk of degrading the sensor and delivering wrong measurements during the first hours of use after the system is switched on again.

Since the levels of current variation at the output of the sensor are extremely low, i.e. a few nA, the interfacing electronics must be as little noisy as possible to avoid degrading the SNR (signal to noise ratio). Beyond the use of low noise electronics dedicated to this type of measurement, the routing of the printed circuit tracks must also be carried out with care. The tracks must be as short as possible and avoid loops, which would capture the neighboring magnetic field and increase the noise captured by the track, hence lowering the SNR.

The Texas Instrument AFE was tested and compared against the Alphasense AFE during lab experiments. A desiccator served as a controlled environment where various steps and ramps of gas

pollutant concentrations were applied. As shown in **Figure 1**, the signals obtained with the Texas Instrument AFE are much noisier than those obtained with the Alphasense AFE. However, when a 1-min running mean is applied, the different steps are much more visible in all signals, and eventually when calibration factors are applied, we can observe a pretty good match between both output signals. The gas sensor itself was switched several times from one AFE to the other to prevent its potential effect on the quality of the signal.

The embedded system is based on the Microchip ATmega2560 8-bits microcontroller because it allows for very fast hardware and software prototyping with the Arduino Mega development kit and includes the interfaces required for this project: I<sup>2</sup>C for the AFE, the accelerometer and the environmental sensor, UART for the GPS and the PM sensor, and SPI for the SD card. The general architecture of the Antilope's electronics is shown in **Figure 2**. Further developments have led to the inclusion of a BLE (Bluetooth Low Energy) module that establishes a wireless link between the Antilope and any compatible device e.g. smartphone.

## Hardware: Enclosure

The enclosure was designed to be 3D printed, allowing for a quick and cheap prototyping. It needed to protect as much as possible the electronics and the sensors from dust and rain but also to ensure ventilation in the direct vicinity of the gas sensors. The choice made was to have numerous slots, tilted at an angle of 45°, on the three sides surrounding the electrochemical sensors, allowing for air inflow and preventing, at least partly, rain to enter the housing when the device keeps its regular vertical orientation. The SD card slot and the micro USB type B port used for power supply are both located on one side of the box, with a little extension protecting them from direct rain.

A 3-part design was considered to facilitate the assembly of the Antilope; its components are shown in **Figure 3**. The bottom part contains the main PCB, on which are mounted the accelerometer, the PM and the gas sensors. The middle part acts as a ring onto which the other parts, namely the environmental condition sensor and the GPS, are attached. The lid is bolted into the bottom part and keeps the ring in place. A FDM (Fused Deposition Modeling) printer was used to make this housing for it is easy, cheap and quick, and offers custom ways of prototyping. PLA (Polylactic acid) filament was chosen as the base material for the enclosure.

## Software

To avoid coding in bare metal C, which can quickly become time-consuming, Sparkfun's Arduino-based libraries were used to control the different computer buses with sensors. They simplify the programming and allow one to spend his time on the application code layer.

The data acquisition is done every second. The sampling period is based on a timer/counter overflow, which is matched, once a day at midnight, with the GPS time for logging. Records are stored in a FAT-formatted SD card within a daily CSV file that contains the date, time, location, PM<sub>2.5</sub>, NO, NO<sub>2</sub>, O<sub>3</sub>+NO<sub>2</sub> levels, shock detection, temperature,

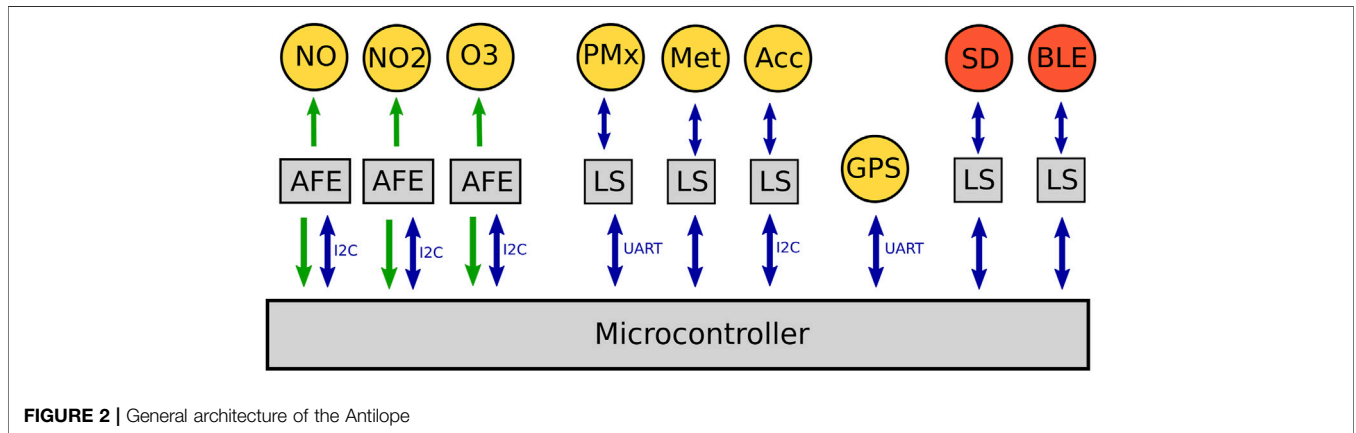
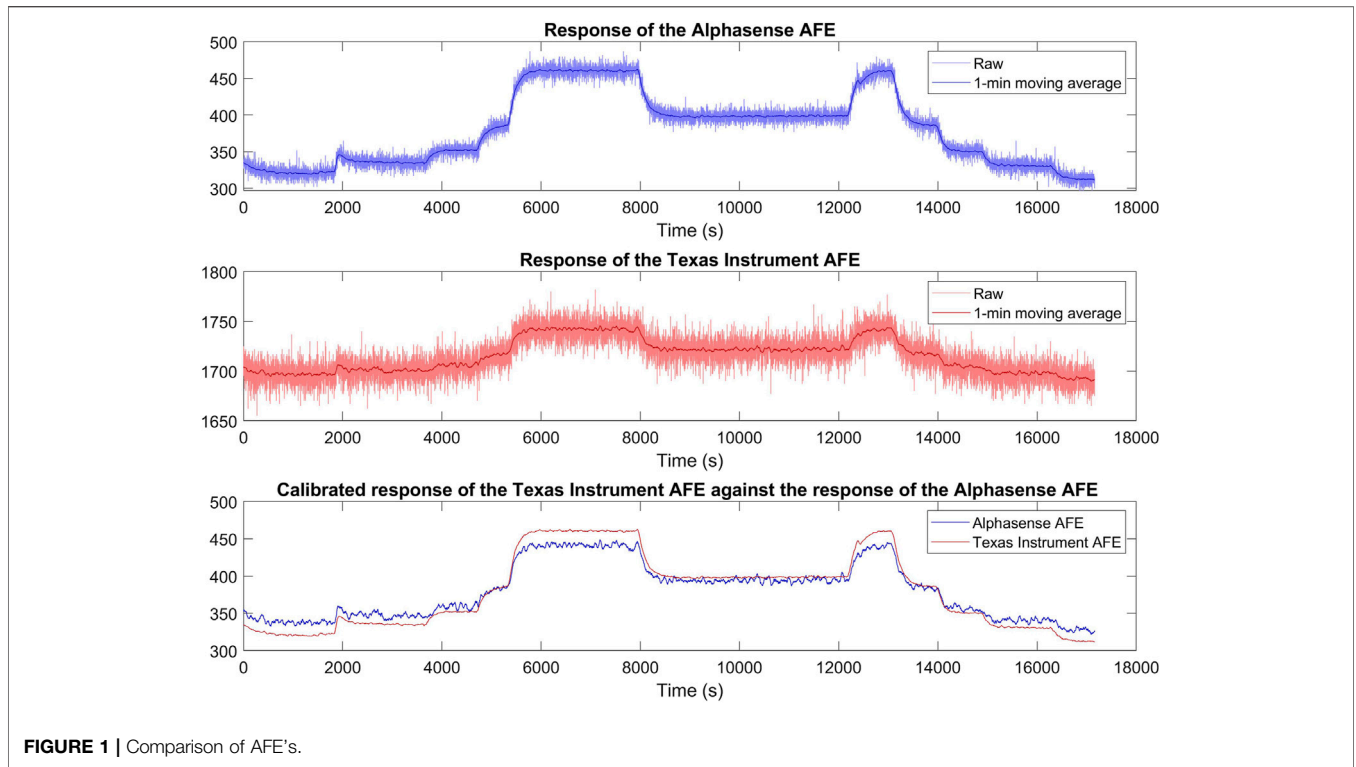

barometric pressure and relative humidity. The gas concentrations are provided as raw signals, they need a transformation to be expressed in ppb or  $\mu\text{g}\text{m}^{-3}$ .

## RESULTS

### Side-by-Side Experiments

One of the most common applications with low-cost sensors is the densification or the creation of a complementary monitoring network. In order to evaluate the performance of our device, we set two of them up side by side with reference instruments at the urban traffic station of Antwerp-Borgerhout (Belgium) run by

VMM (Vlaamse Milieumaatschappij), and at the urban background station of Liège-Val-Benoît (Belgium) run by ISSeP (Institut Scientifique de Service Public).

Two systems were used in Antwerp alongside a certified fine dust measurement device from Palas, the FIDAS 200; this experiment was part of a longer and larger comparison exercise led in the framework of the VAQUUMS project ([https://vaquums.eu/sensor-db/tests/life-vaquums\\_PMfieldtest.pdf/view](https://vaquums.eu/sensor-db/tests/life-vaquums_PMfieldtest.pdf/view)). **Figure 4** shows the  $\text{PM}_{2.5}$  time series obtained before (top panel) and after correction (bottom panel). Both LCSS were in good agreement with the reference analyzer: the correlation coefficients were 0.95 and 0.93, and the RMSE (Root-Mean-Square Error) 5.14 and 6.22  $\mu\text{g}\text{m}^{-3}$ . After a simple calibration



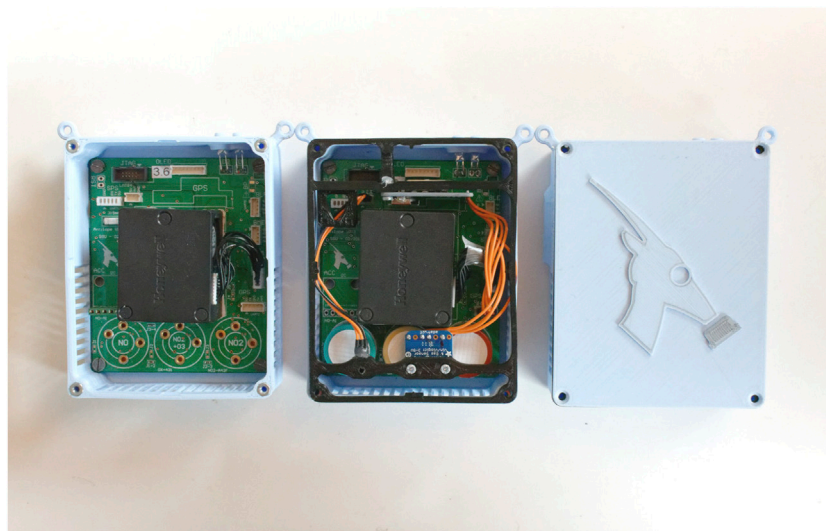

**FIGURE 3** | Enclosure of the Antilope.

(linear regression), computed over the whole considered period, RMSE decrease to 2.25 and 2.58  $\mu\text{g m}^{-3}$ . No correction linked to the environmental conditions was applied.

To illustrate the performance evaluation of the electrochemical sensors, we present a 1-week comparison of ozone concentrations measured in Liège by 18 Antilope and a certified analyzer from Horiba, the APOA370. In practice, we usually make such a comparison exercise between two batches of subjects for the personal exposure experiment but on a shorter period of two to 3 days. **Figure 5** shows the  $\text{O}_3$  time series obtained by using the sensor's lab-defined sensitivity and zero current values (top panel) and by applying a correcting bias and gain (bottom panel). Since a linear transformation is applied, correlation coefficients between the different instruments are in the same range in both cases (0.49; 0.92) with a mean value of 0.82. The range of the RMSE decreases from (20; 245)  $\mu\text{g m}^{-3}$  to (8; 18)  $\mu\text{g m}^{-3}$  with a mean value of 120 and 11  $\mu\text{g m}^{-3}$  respectively.

## Personal Exposure

In the personal exposure part of the project, every 2 weeks four subjects living in the cities of Liège and Namur were provided with an Antilope, an AethLabs AE51 aethalometer and a GlobalSat DG200 GPS for 7 days. Instructions about the instrument use and charging were given orally but some video tutorials were also available. All the measurement equipment was placed in the nest of a backpack to easily shadow the subjects in their daily activities.

At the beginning of their 1-week experiment, subjects had to fill in a questionnaire about their profile (age, gender, professional status, etc.), their health in general (allergy or asthma, frequency of physical activities, smoking exposure, etc.) and their environment with questions about their house (heating type, ventilation, kitchen and floor equipment, etc.), their habits (most occupied rooms, vacuum frequency, etc.) as well as their place of work if appropriated.

During the week, participants had to fill in a journey log-book with all their activities. Each activity had to be characterized by a start time, an end time, a type (work, shopping, staying at home, cooking, sport, leisure, etc.) and an environment (indoor or outdoor). Travels are considered as an activity with an indoor/outdoor type depending on the mode of transport (car, bus, train, walk, etc.). Finally, subjects also had to report every day any respiratory discomfort or crisis.

Such information is very useful to evaluate exposure to air pollution according to activities and modes of transport and to corroborate some of the measurements such as the location provided by the GPS or the lack thereof.

**Figure 6** shows BC and  $\text{PM}_{2.5}$  concentrations measured by one subject during 24 h of his 1-week experiment. In this case, one can clearly see peaks related to daily car journeys for both pollutants; indoor measurements of these pollutants seem to be much less correlated. Anecdotally, one can value the precision of this subject when reporting timestamps in the log-book.

A preliminary analysis of 72 candidates has shown that cooking was the activity where people are exposed to the highest  $\text{PM}_{2.5}$  concentrations (28  $\mu\text{g m}^{-3}$ ), followed by indoor sport (23  $\mu\text{g m}^{-3}$ ) and outdoor leisure activities (excluding sport) (17  $\mu\text{g m}^{-3}$ ). As shown by Shehab et al. (2021) and Hu et al. (2012) even cooking with an electric stove emits particulate matter, as a result of the burning of the food itself. At the bottom of the list is shopping in the city (7  $\mu\text{g m}^{-3}$ ). We did not consider activities with less than 10 h of cumulated duration for this analysis. The variation range of relative humidity during these activities only spanned from 26–35%, it is thus difficult to consider it as a major factor to explain the differences. Regarding the transport, on average bus commuters were exposed to 21  $\mu\text{g m}^{-3}$ , pedestrians to 16  $\mu\text{g m}^{-3}$ , cyclists to 12  $\mu\text{g m}^{-3}$  and car drivers to 8  $\mu\text{g m}^{-3}$ .

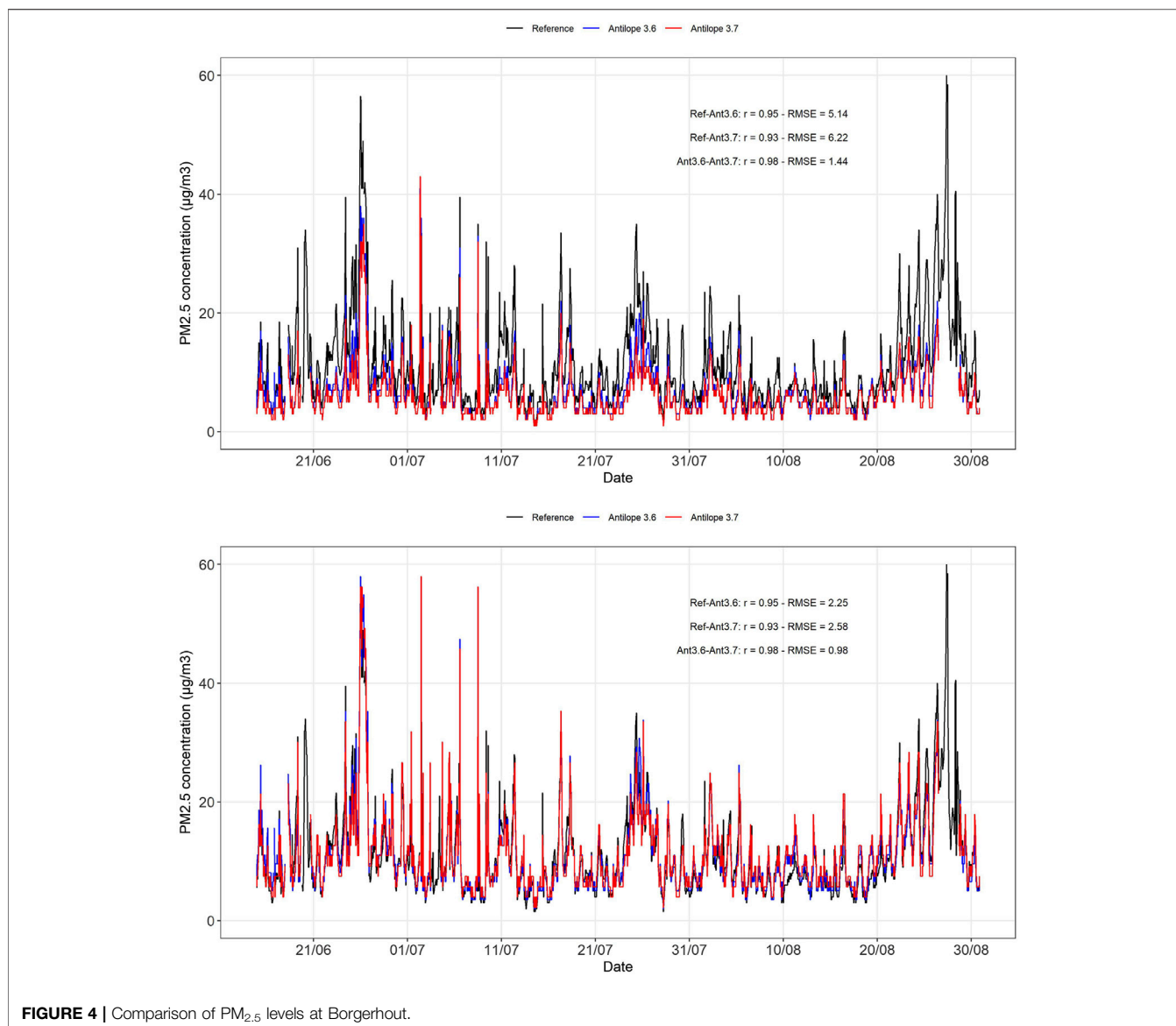

FIGURE 4 | Comparison of PM<sub>2.5</sub> levels at Bergerhout.

## DISCUSSION

The LCSS that was designed and built, for a manufacturing price less than 500 € as a prototype, and probably much lower if serial production was carried out, fulfilled satisfactorily our goals. The Antilope has shown real potential for both complementary measurement and personal exposure assessment applications. However, it is clear that a more comprehensive validation campaign, including longer time periods, a larger variability in meteorological conditions and a broader spectrum of monitoring station type would be necessary before drawing any final conclusions about the performance of the LCSS. A thorough examination of all candidates' information and measurements would also be required before stating, for example, that it is safer, in terms of exposure to air pollution, to drive a car rather than to walk.

Regular use of our devices has pointed out what were their main flaws, what could be improved in general and what could be improved depending on the considered application. Here are some elements that should be taken into account for the next version of our system and by people who would like to build their own LCSS.

The use of an external battery offers flexibility to reach a sufficient operation lifetime. A 5200 mAh power bank has a large enough capacity for a 60-h operation but, because there is a cable, it is no more convenient than using a 20,000 mAh power bank that could also supply power to other equipment simultaneously. Another problem due to the cable is the risk of disconnection. It happened quite frequently, especially during bike travels of our subjects. Possible improvements would be to include the battery inside the enclosure, even if it means it would be bulkier, to use a power bank with solar cells or any alternative recharging system. For fixed measurement without power mains, we used two to

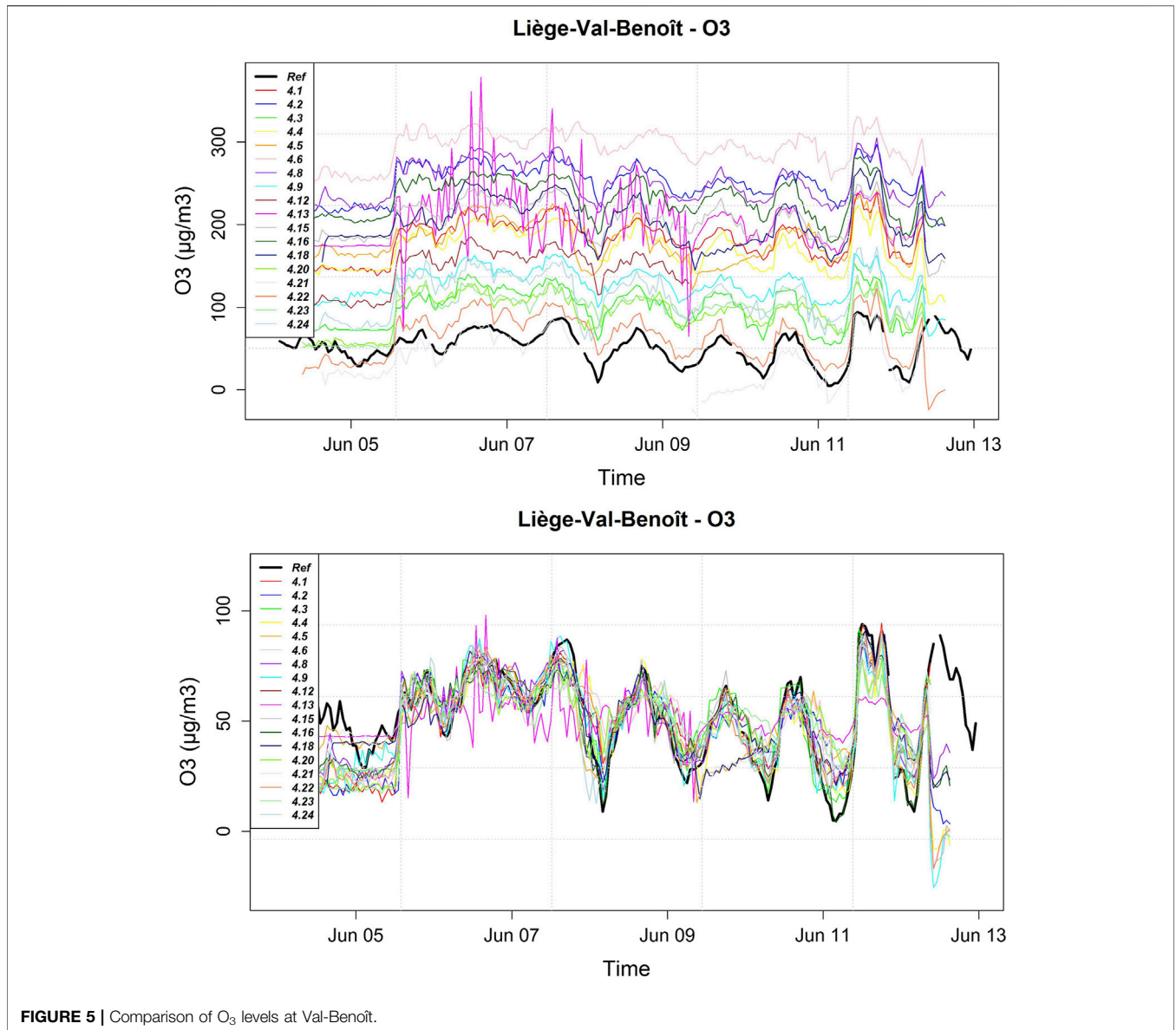

FIGURE 5 | Comparison of O<sub>3</sub> levels at Val-Benoît.

three large capacity power banks in cascade; it somewhat extended the operation lifetime, though not proportionally. Two possible improvements would be to reduce power consumption by switching the PM sensor part time off and to add a solar panel, even if measurements might become less accurate and price could significantly increase, respectively.

The gas sensor resolution is limited by the ADC. A look at short time series, e.g. during a lab test where successive increasing levels of NO<sub>2</sub> concentrations are applied (see left panel of Figure 7), helps us to see the discrete nature of the signal collected by the Antilope. In our case (with a 10-bit ADC), the smallest voltage difference that can be observed is  $dV = \frac{2500}{2^{10}}10^6 = 2.44 \cdot 10^6$  nV, the smallest corresponding current difference is  $dI = \frac{dV}{R} = \frac{2.44 \cdot 10^6}{512 \cdot 10^3} = 4.77$  nA and the smallest corresponding concentration difference is  $dC = \frac{dI}{Sensitivity} \cdot 10^3 \text{ ratio}_{ppb} : \mu\text{gm}^{-3} = \frac{4.77}{400} \cdot 10^3 \cdot 1.91 = -22.77 \mu\text{gm}^{-3}$ ,

when considering a sensitivity of  $-400 \text{ nA ppm}^{-1}$  and a  $\text{ppb}:\mu\text{gm}^{-3}$  conversion factor of 1.91 (at 20°C and 1 atm). Such a value makes it difficult to perform a precise measurement of small fluctuations e.g.  $1\text{--}5 \mu\text{gm}^{-3}$ . The easiest way to improve the resolution would be to use a 12- or 16-bit ADC. In that case, the noise of the AFE would certainly become the limiting factor, in which case one could either develop its own potentiostat or use existing low-noise breakouts.

Since satellites are not detected by the GPS when indoor, clock synchronization is impossible and timestamping becomes inaccurate. Furthermore, even outdoor, the data stream was sometimes erratic. The actual problem was never identified. Possible improvements would be to use a second clock or to be able to set time manually.

Since the date is not always known by the Antilope, it was decided to use a counter for naming the daily file. Unfortunately,

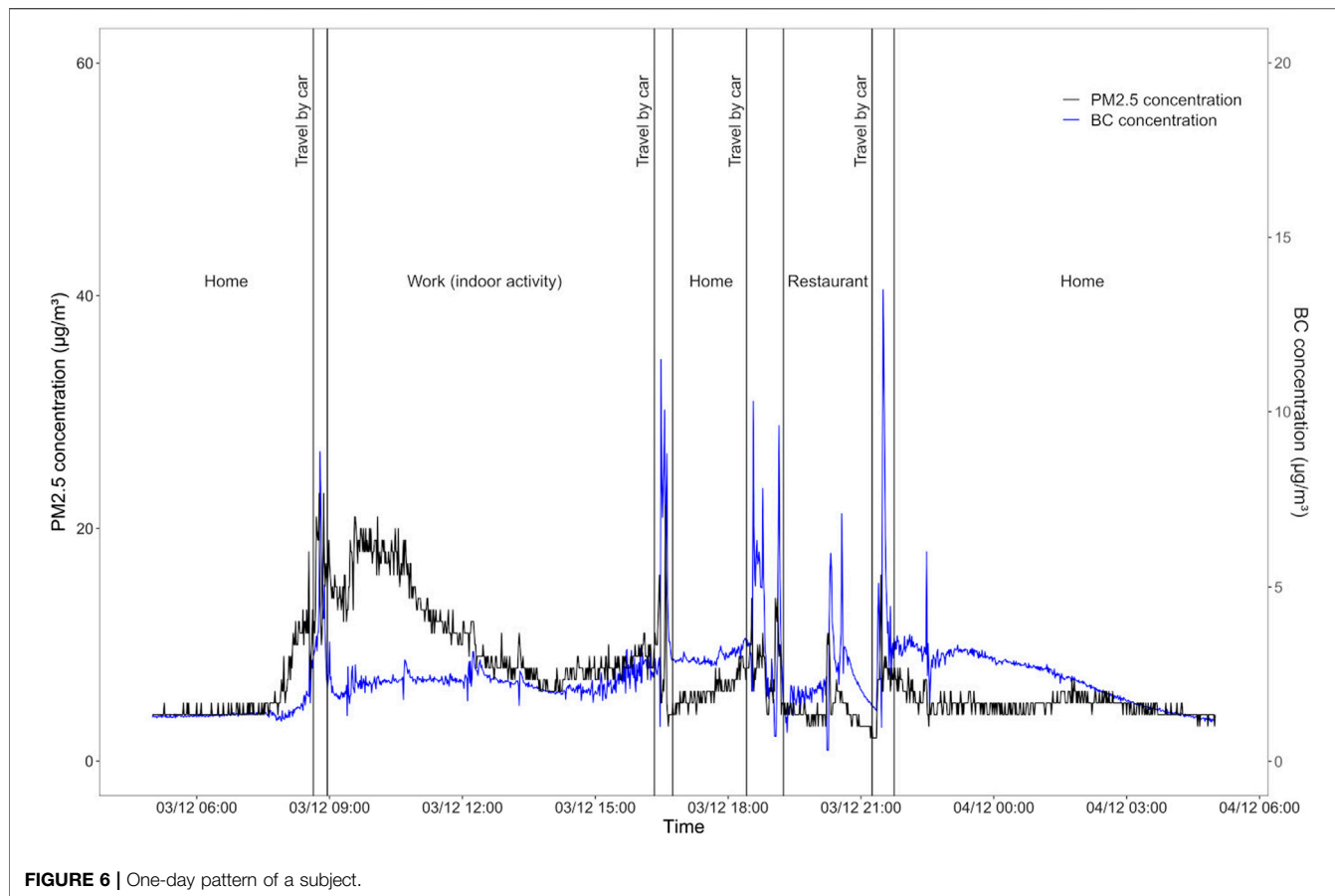

FIGURE 6 | One-day pattern of a subject.

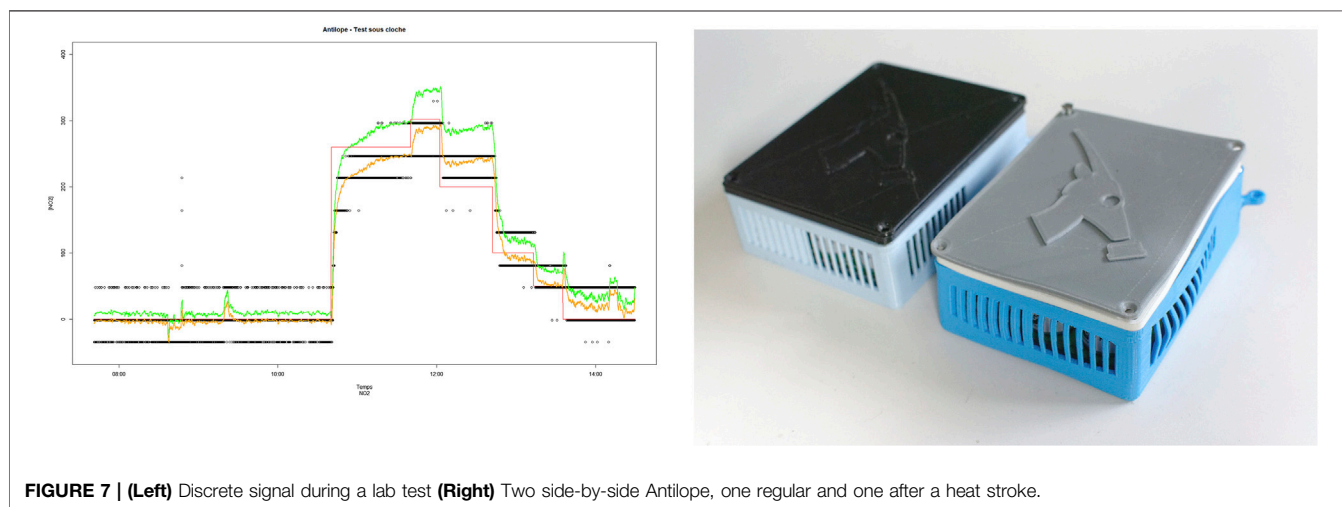

FIGURE 7 | (Left) Discrete signal during a lab test (Right) Two side-by-side Antilope, one regular and one after a heat stroke.

we did not consider letting our devices out in the field for long periods and eventually the 1-to-99 counter was insufficient for our use. This has been easily corrected by modifying the software, allowing us to make longer records.

Another limitation for long measurement campaigns is the absence of a communication system. The 8 Gb SD card can easily store months and months of data but it is useful to have from time

to time a look at the records, e.g. to check whether the system is working properly or to calibrate the output values from the electrochemical sensors. The addition of a GPRS communication module would solve the problem but also increase the power consumption. In order to easily check the data *via* smartphone when setting up the system, a BLE module was added later but obviously it does not help for



sending data in real time if no one leaves his smartphone close to the Antilope.

Finally, the enclosure could also probably be improved, though it is very difficult to make it completely waterproof: on the one hand because of the numerous apertures allowing for the inflow of ambient air, on the other hand because a too thin PLA wall will leak. A way to solve this issue would be to print thicker layers or to coat the PLA with some epoxy resin. Additionally, PLA is not the most solid material mechanically or thermally. Right panel of **Figure 7** shows the effect of exposure to high temperature (>45°C) for several hours in a car.

## DATA AVAILABILITY STATEMENT

The raw data supporting the conclusion of this article will be made available by the authors, without undue reservation.

## ETHICS STATEMENT

Ethical review and approval was not required for the study on human participants in accordance with the local legislation and institutional requirements. The patients/participants provided their written informed consent to participate in this study.

## REFERENCES

- AIRLAB Microsensors Challenge (2021). *Protocol*. [http://www.airlab.solutions/sites/default/files/Protocole%20-%20Challenge\\_Microcapteurs%202021%20EN.pdf](http://www.airlab.solutions/sites/default/files/Protocole%20-%20Challenge_Microcapteurs%202021%20EN.pdf).
- Baron, R., and Saffell, J. (2017). Amperometric Gas Sensors as a Low Cost Emerging Technology Platform for Air Quality Monitoring Applications: A Review. *ACS Sensors* 2, 1553–1566. doi:10.1021/acssensors.7b00620
- Castell, N., Kobernus, M., Liu, H.-Y., Schneider, P., Lahoz, W., Berre, A. J., et al. (2015). Mobile technologies and services for environmental monitoring: The CitiSense-MOB approach. *Urb Clim*. 14, 370–382. doi:10.1016/j.uclim.2014.08.002
- Chou, J. (1999). *Hazardous Gas Monitors, A Practical Guide to Selection, Operation and Applications*. New York: McGraw-Hill and SciTech Publishing.
- Fishbain, B., Lerner, U., Castell, N., Cole-Hunter, T., Popoola, O., Broday, D. M., et al. (2017). An evaluation tool kit of air quality micro-sensing units. *Sci. Total Environ*. 575, 639–648. doi:10.1016/j.scitotenv.2016.09.061
- Gerboles, M., Spinelle, L., and Signorini, M. (2015). “AirSensEUR: an open data/software/hardware multi-sensor platform for air quality monitoring,” in *Part A: sensor shield* (Luxembourg: Publications Office of the European Union). doi:10.2788/30927
- Gerboles, M., Spinelle, L., Signorini, M., and Kotsev, A. (2016). “AirSensEUR: an open data/software/hardware multi-sensor platform for air quality monitoring,” in *Part B: Host, influx datapush and assembling of AirSensEUR* (Luxembourg: Publication Office of the European Union). doi:10.2790/214743
- Hu, T., Singer, B. C., and Logue, J. M. (2012). *Compilation of Published PM<sub>2.5</sub> Emission Rates for Cooking, Candles and Incense for Use in Modeling of Exposures in Residences, LBNL Report Number Pending*. <https://www.osti.gov/servlets/purl/1172959>.
- Karagulian, F., Gerboles, M., Barbieri, M., Kotsev, A., Lagler, F., and Borowiak, A. (2019). *JRC Technical Reports - Review of sensors for air quality monitoring*. Luxembourg: Publications Office of the European Union. doi:10.2760/568261

## AUTHOR CONTRIBUTIONS

SG, CB and VB are the designers of the Antilope, they have worked on the enclosure, the software and the main board and interfacing electronics development. VH has carried out the personal exposure part of the project taking place in Namur. BB has brought some information about sensor technologies and their evaluation. MD has carried out the personal exposure part of the project taking place in Liège and performed the related data analysis. FL is the coordinator of the OIE project and has performed the data analysis of the side-by-side experiments.

## FUNDING

This research project was supported by ISSeP in the framework of the application of the Loi programme du 8 août 2003, article 275, alinéa 3 du Code sur l'impôt des revenus, mécanisme Moerman.

## ACKNOWLEDGMENTS

We would like to thank Didier Muck and Nicolas Fernemont who helped us with the set up and the execution of the measurement campaigns, Laurent Spanu who provided us with useful R scripts and Pierre Crespin who managed the databases and the online survey for the personal exposure part of the project. We are also grateful to Evelyne Elst, the coordinator of the VAQUUMS project for having our devices running at Antwerp.

- Lewis, A., von Schneidmesser, E., and Peltier, R. E. (2018). *Low-cost sensors for the measurement of atmospheric composition: overview of topic and future applications: valid as of May 2018*. Geneva: WMO, 1215. [https://library.wmo.int/doc\\_num.php?explnum\\_id=9881](https://library.wmo.int/doc_num.php?explnum_id=9881).
- Mahajan, S., and Kumar, P. (2020). Evaluation of low-cost sensors for quantitative personal exposure monitoring. *Sust. Cities Soc.* 57, 102076. doi:10.1016/j.scs.2020.102076
- Mead, I., Popoola, O., Stewart, G., Landshoff, P., Calleja, M., Hayes, M., et al. (2013). The use of electrochemical sensors for monitoring urban air quality in low-cost, high-density networks. *Atmos. Environ.* 70, 186–203. doi:10.1016/j.atmosenv.2012.11.060L
- Peltier, R. E., Castell, N., Clements, A. L., Dye, T., Hüglin, C., Kroll, J. H., et al. (2020). *An update on low-cost sensors for the measurement of atmospheric composition*. Geneva, Switzerland: WMO.
- Polidori, A., Feenstra, B., Papapostolou, V., and Zhang, H. (2017). *Field Evaluation of Low-cost Air Quality Sensors. South Coast Air Quality Management District (SCAQMD), Diamond Bar, California*. <http://www.aqmd.gov/docs/default-source/air-spec/protocols/sensors-field-testing-protocol.pdf?sfvrsn=0>.
- Romain, A. C. (2018). *Microcapteurs gaz et capteurs électrochimiques*. Workshop presentation. Liège: ULiège.
- Schneider, P., Bartonova, A., Castell, N., Dauge, F. R., Gerboles, M., Hagler, G. S. W., et al. (2019). Toward a Unified Terminology of Processing Levels for Low-Cost Air-Quality Sensors. *Environ. Sci. Tech.* 53, 8485–8487. doi:10.1021/acs.est.9b03950
- Shehab, M., Pope, F. D., and Delgado-Saborit, J. M. (2021). The contribution of cooking appliances and residential traffic proximity to aerosol personal exposure. *J. Environ. Health Sci. Eng.* 19 (1), 307–318. doi:10.1007/s40201-020-00604-7
- Spinelle, L., Aleixandre, M., and Gerboles, M. (2013). *Protocol of evaluation and calibration of low-cost gas sensors for the monitoring of air pollution*. Luxembourg: Publications Office of the European Union. doi:10.2788/9916

- Spinelle, L., Gerboles, M., Villani, M. G., Aleixandre, M., and Bonavitacola, F. (2015). Field calibration of a cluster of low-cost available sensors for air quality monitoring. Part A: Ozone and nitrogen dioxide. *Sens. Actuator B-chem.* 215, 249–257. doi:10.1016/j.snb.2015.03.031
- Spinelle, L., Gerboles, M., Villani, M. G., Aleixandre, M., and Bonavitacola, F. (2014). Calibration of a cluster of Low-cost sensors for the measurement of air pollution in ambient air. *IEEE SENSORS 2014 Proc. IEEE*, 21–24.
- Wesseling, J., de Ruiter, H., Blokhuis, C., Drukker, D., Weijers, E., et al. (2019). *Development and Implementation of a Platform for Public Information on Air Quality, Sensor Measurements, and Citizen Science. In Atmosphere.* 10(8), Bilthoven: Presentation for FAIRMODE. [https://fairmode.jrc.ec.europa.eu/document/fairmode/event/presentation/Madrid2019/201910FAIRMODE\\_RIVM\\_Wesseling\\_exp.pdf](https://fairmode.jrc.ec.europa.eu/document/fairmode/event/presentation/Madrid2019/201910FAIRMODE_RIVM_Wesseling_exp.pdf).
- Yi, W. Y., Lo, K. M., Mak, T., Leung, K. S., Leung, Y., and Meng, M. L. (2015). A Survey of Wireless Sensor Network Based Air Pollution Monitoring Systems. *Sensors* 15, 31392–31427. doi:10.3390/s151229859

**Conflict of Interest:** The authors declare that the research was conducted in the absence of any commercial or financial relationships that could be construed as a potential conflict of interest.

**Publisher's Note:** All claims expressed in this article are solely those of the authors and do not necessarily represent those of their affiliated organizations, or those of the publisher, the editors and the reviewers. Any product that may be evaluated in this article, or claim that may be made by its manufacturer, is not guaranteed or endorsed by the publisher.

Copyright © 2021 Lenartz, Dury, Bergmans, Hutsemékers, Broun, Brose and Guichaux. This is an open-access article distributed under the terms of the Creative Commons Attribution License (CC BY). The use, distribution or reproduction in other forums is permitted, provided the original author(s) and the copyright owner(s) are credited and that the original publication in this journal is cited, in accordance with accepted academic practice. No use, distribution or reproduction is permitted which does not comply with these terms.