



Correlation of PK/PD Indices with Resistance Selection for Cefquinome against *Staphylococcus aureus* in an *In Vitro* Model

Yafei Li^{1†}, Baoyi Feng^{1†}, Xiaoyan Gu², Dawei Yang³, Zhenling Zeng¹, Bingxu Zhang¹ and Huanzhong Ding^{1*}

¹ Laboratory of Veterinary Pharmacology, College of Veterinary Medicine, South China Agricultural University, Guangzhou, China, ² Centre for Veterinary Drug Residues, College of Veterinary Medicine, South China Agricultural University, Guangzhou, China, ³ China Institute of Veterinary Drug Control, Beijing, China

OPEN ACCESS

Edited by:

Alexandre Gonçalves,
Universidade de Trás-os-Montes
e Alto Douro, Portugal

Reviewed by:

Dmitri Debabov,
NovaBay Pharmaceuticals, Inc., USA
William Farias Porto,
Universidade Católica de Brasília,
Brazil

*Correspondence:

Huanzhong Ding
hzding@scau.edu.cn

† These authors have contributed
equally to this work.

Specialty section:

This article was submitted to
Antimicrobials, Resistance
and Chemotherapy,
a section of the journal
Frontiers in Microbiology

Received: 30 August 2015

Accepted: 21 March 2016

Published: 12 April 2016

Citation:

Li Y, Feng B, Gu X, Yang D, Zeng Z,
Zhang B and Ding H (2016)
Correlation of PK/PD Indices with
Resistance Selection for Cefquinome
against *Staphylococcus aureus*
in an *In Vitro* Model.
Front. Microbiol. 7:466.
doi: 10.3389/fmicb.2016.00466

Cefquinome is a fourth-generation Cephalosporin approved for use in animals exclusively. The objective of this study was to explore the relationship of cefquinome pharmacokinetic/pharmacodynamic (PK/PD) indices with resistance selection of *Staphylococcus aureus* ATCC25923 in an *in vitro* model. Six dosing regimens of cefquinome at an interval of 24 h for three consecutive times were simulated, resulting in maximum concentrations (C_{max}) from 1/2 to 16MIC and terminal half-lives ($t_{1/2\beta}$) of 3 and 6 h, respectively. The *in vitro* sensitivity of *S. aureus* was monitored by bacterial susceptibility and dynamic time-kill curve experiments over the six cefquinome concentrations. The correlation between changes in bacterial susceptibility (MIC_{72}/MIC_0) and the percentage of time within mutant selection window versus dosing interval (T_{MSW} %) was subjected to the Gaussian function and regression analysis. Our results favored the consensus that time above MIC ($T > MIC$) was recognized as an important PK/PD parameter of cephalosporins for antibacterial efficiency. Cefquinome reached the maximum killing effect when $T > MIC\%$ attained approximately 40~60%. The subsequent correlation analysis demonstrated that resistant *S. aureus* ATCC25923 was easy to occur when $T_{MSW}\%$ attained an index of about 20% with $t_{1/2\beta}$ of 3 h after multiple dosing, and 40% with $t_{1/2\beta}$ of 6 h after multiple dosing, respectively.

Keywords: cefquinome, *Staphylococcus aureus*, PK/PD, MPC, *in vitro* model

INTRODUCTION

Staphylococcus aureus is a major pathogen for animals and humans, which contributes to a variety of severe infections, including bacteremia, meningitis, endocarditis, skin and wood infection or other diseases for animals and humans (Archer, 1998; Lowy, 1998; Azizoglu et al., 2013). More importantly, *S. aureus* plays an important role in the food contamination by foodborne pathogens. Food poisoning caused by staphylococcal enterotoxin (SE) is a pressing worldwide health problem (Tauxe, 2002; Le Loir et al., 2003). In spite of the progress in antimicrobial therapy, treatment of *S. aureus* infection has become more and more challenging

because drug-resistance of *S. aureus* has increased globally over the past decade. The methicillin-resistant *S. aureus* (MRSA) and vancomycin-resistant *S. aureus* (VRSA) were particularly reported and well documented (Harris et al., 2010; Mohammed Fayaz et al., 2011).

In veterinary medicine, cefquinome (CEQ) has been licensed in European countries by virtue of its broad antibacterial spectrums and remarkable antibacterial activities. Despite of this, the cephalosporins should be in prudent use considering the escalating antimicrobial resistance. Evidence has showed that different animal species may harbor the same resistance determinant and are recognized as possible reservoirs of antimicrobial-resistant bacteria (Guardabassi et al., 2004). It has been also observed that cefquinome exerted a selective effect on *bla*_{CTX-M} producing *Escherichia coli* strains (Cavaco et al., 2008). Therefore, further information concerning the ability of cefquinome to prevent occurring of resistant strains seems to be investigated.

Since mutant prevention concentration (MPC) of antibiotics was first described by Dong et al. (1999), it has been successfully applied to evaluate the ability of antibiotics that restrict the selection of resistant strains (Allen et al., 2004; Allen and Hankins, 2009; Wang et al., 2010; Blondeau et al., 2012) and optimize the current dosing regimens of antibiotics to slow the emergence of resistant strains. MPC was taken as the lowest doubling dilution drug concentration that prevented a population of 10^{10} colony forming unit (CFU)/mL or even more microorganisms from first-step mutation. Zone of the drug concentrations between minimum inhibitory concentration (MIC) and MPC was defined as the mutant selection window (MSW). MPC and MSW concepts, representing the ability of antibiotics to select resistant strains, have been tested in various *in vitro* studies (Allen et al., 2004; Croisier et al., 2004b; Ferran et al., 2007), in *ex vivo* pharmacodynamic studies (Bronner et al., 2002) and in *in vivo* studies (Croisier et al., 2004a; Cui et al., 2006). Here, we developed an *in vitro* kinetic model to investigate the relationship between pharmacokinetic/pharmacodynamic (PK/PD) indices of cefquinome with terminal half-lives ($t_{1/2\beta}$) of 3 or 6 h and resistance development of *S. aureus* ATCC25923.

MATERIALS AND METHODS

Antimicrobial Agents, Medium, and Bacterial Strains

Raw material of cefquinome (purity of 84.1%) was obtained from Hebei yuansheng Pharmaceutical Enterprise, Co., Ltd. Mueller-Hinton broth (MHB) and agar were purchased from Guangzhou huankai Comapany. *S. aureus* ATCC 25923 was purchased from the China Institute of Veterinary Drug Control (Beijing, China).

In Vitro Susceptibility Testing

The MIC of CEQ against *S. aureus* with an inoculum of 5×10^5 CFU/mL was determined by standard agar dilution method established by the Clinical and Laboratory Standards Institute (CLSI).

Measurement of MIC₉₉, Mutant Prevention Concentration (MPC) and Selection Index (SI)

The MIC₉₉ was defined as the drug concentration that inhibited 99% of bacteria colony formation. MPC was reckoned as the lowest cefquinome concentration blocking $\geq 10^{10}$ CFU/mL inoculants growth. The measurements of MIC₉₉ and MPC were mainly based on the method reported by Zhao and Drlica (2002) with slight modification. For MIC₉₉, agar plates containing a series of cefquinome (concentrations ranging from 0.5 to 0.164 $\mu\text{g/mL}$) at 20% per sequential decrease were prepared. 3×10^7 CFU/mL *S. aureus* suspension in logarithmic phase of growth was then subjected to serial 10-fold dilutions with MHB to 3×10^2 CFU/mL bacteria. Again, 100 μL of each dilution was plated onto the agar plates containing the series of CEQ concentrations mentioned above and incubated at 37°C overnight. Bacterial colonies that recovered growth in each dilution were counted. Drug concentrations versus the percentages of colony recovery were plotted and the interpolation method was adopted to calculate the cefquinome concentration blocking 99% bacteria growth.

The determination of MPC was similar to that of MIC₉₉. Instead, 100 μL of 10^{10} CFU/mL inoculants was spread on agar plates containing a series of antimicrobial concentrations. The lowest antimicrobial concentration preventing bacterial colony formation at 72 h after incubation was measured as provisional mutant prevention concentration (MPC_{pr}). A second determination that utilized linear MPC_{pr} decreases (about 20% per sequential decrease) was performed. MPC was the lowest CEQ concentration preventing 100% growth of *S. aureus* colony.

The calculated ratio of MPC/MIC₉₉ for *S. aureus* was defined as selection index (SI) of cefquinome.

In Vitro Dynamic PK/PD Model Simulation

A previous described dynamic model (Grasso et al., 1978) with modification was developed in this study. One-compartment open model with first-order absorption of pharmacokinetics for cefquinome was simulated. The schematic representation of *in vitro* PK/PD model used is depicted in Figure 1. Briefly, the system was mainly composed of three sealed containers

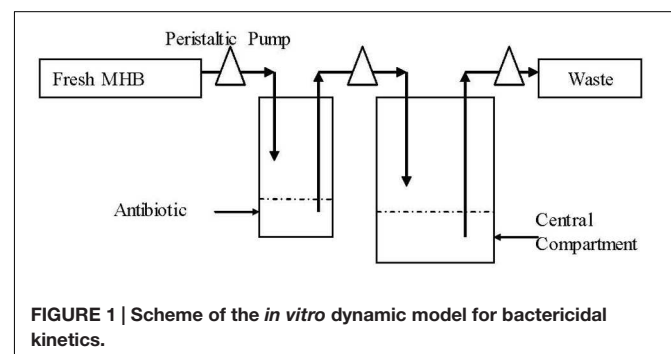

FIGURE 1 | Scheme of the *in vitro* dynamic model for bactericidal kinetics.

(compartments) and they were connected with peristaltic pumps in line, each containing sterile MHB and a magnetic stirrer to ensure adequate mixing. One 500 mL sealed compartment containing 300 mL MHB, provided with either a bacterial culture alone (control growth experiments) or a bacterial culture plus antibiotic (killing/re-growth experiments), acted as the central chamber. Another 100 mL sealed container charged with 60 mL of sterile MHB, acted as the absorption chamber, with desired calculated drug concentrations. The third one was used to provide fresh MHB. Waste was also collected. Peristaltic pumps circulated fresh broth to central and absorption compartments at the desired flow rate. The flow rate of the pump was set on the basis of the terminal half-life being simulated. A series of dosage regimens were designed to generate different CEQ concentration profiles with terminal half-lives of 3 and 6 h for three consecutive administrations in this apparatus.

***In Vitro* PK/PD Model and CEQ Dosing Regimens**

The apparatus ran under 37°C. The elimination terminal half-lives of cefquinome reported in the literature varied from 0.5 to 10 h (Limbert et al., 1991; Li et al., 2008; Al-Taher, 2010; Tohamy, 2011; Yuan et al., 2011; Zonca et al., 2011; Dumka et al., 2013), therefore, 3 and 6 h were selected in our study. Peristaltic pumps circulated fresh MHB medium to and from the central compartment at a flow rate of 15.75 r/min for $t_{1/2\beta}$ of 3 h or 7.86 r/min for $t_{1/2\beta}$ of 6 h, respectively. 3 mL bacterial suspensions (10^8 CFU/mL) at the logarithmic phase were injected into the central compartment container. The bacteria were incubated in the model for 2 h to result in exponentially growing cultures before addition of cefquinome. Antibiotic doses were calculated to generate CEQ initial concentrations of 1/2MIC, MIC, 2MIC, 4MIC, 8MIC, and 16MIC levels, respectively. The *in vitro* pharmacokinetics of cefquinome for all doses after three consecutive administrations with 24 h interval for terminal half-lives of 3 and 6 h were simulated.

Quantification of Cefquinome in MHB

Samples were collected from the central compartment immediately before and at 0.5, 1.0, 2.0, 3.0, 4.0, 6.0, 8.0, 10.0, 12.0, and 24.0 h after the first and second administration, and 0.5, 1.0, 2.0, 3.0, 4.0, 6.0, 8.0, 10.0, 12.0, 24.0, 30.0, 36.0, and 48.0 h after the third administration. These samples were stored at -20°C until analysis.

1.5 mL of MHB was extracted for the determination of cefquinome. The concentrations of cefquinome in MHB were analyzed by high-performance liquid chromatography-MS/MS (HPLC-MS/MS) with an assay range of 0.005–0.5 µg/mL. The protein in MHB sample (1 mL) was precipitated by 2 mL acetonitrile, and the supernatant was directly injected into HPLC-MS/MS after high speed centrifugation. Analysis of quality control (QC) samples at three levels (0.01, 0.05, 0.2 µg/mL) showed that the recoveries of the method were above 70%; the intra-day and inter-day coefficients of variation were within 15%. The pharmacokinetic parameters were calculated

by a WinNonlin software (version 5.2.1; Pharsight Corporation, USA).

In Vitro* Time-Kill Experiments and Susceptibility Testing of *S. aureus

To measure the antimicrobial effect of cefquinome with different terminal half-lives against *S. aureus*, the colony count and susceptibility of bacteria in each time point were performed after treatment. Half of each sample was subjected to time-kill kinetic assays. Samples (100 µL) in series of 10-fold dilution with sterile saline (0.9% NaCl) were spread onto Mueller-Hinton agar to determine the number of total or resistant cells. The \log_{10} of surviving *S. aureus* cells (CFU/mL) was plotted against each time point. The other half of each sample was used for the susceptibility test. MIC values of bacteria post-exposed in each time point was conducted using tube dilution method according to the criteria established by the Clinical Laboratory Standards Institute [CLSI] (2013).

Pharmacokinetic/Pharmacodynamic (PK/PD) Integration Analysis

By using the individual pharmacokinetic result from each *in vitro* dosage regimen, the following PK/PD parameters were obtained: ratio of area under the curve of cefquinome concentration versus time to MIC ($AUC_{0-\infty}/MIC$) or ($AUC_{0-24\text{ h}}/MIC$), ratio of area under the curve of cefquinome concentration exceeding MIC to MIC ($AUC_C > MIC/MIC$), time of concentration above MIC ($T > MIC$) or MPC ($T > MPC$), time of concentration within MPC and MIC (T_{MSW}) or expressed as percentage ($T_{MSW}\%$), ratio of $MIC_{72\text{ h}}/MIC_{initial}$ ($MIC_{72\text{ h}}/MIC_{initial}$).

Gaussian function was used to simulate the correlation of $MIC_{72\text{ h}}/MIC_{initial}$ with $T_{MSW}\%$ (percentage of the time during which cefquinome concentrations were inside the MSW). The formula was as follows:

$$y = y_0 + \frac{A}{\sqrt{2\pi}\sigma} e^{-\frac{(x-x_0)^2}{2\sigma^2}}$$

where A was the area under curve and upper baseline; x_0 was the minimum value of $T_{MSW}\%$ which resulted in the maximum $MIC_{72\text{ h}}/MIC_{initial}$.

RESULTS

MIC₉₉ and MPC

The MIC₉₉ and MPC of cefquinome against *S. aureus* ATCC 25923 were 0.4 and 4.096 µg/mL, respectively. So the SI was 10.24 (MPC/MIC₉₉).

***In Vitro* Simulated Pharmacokinetics**

The *in vitro* simulated time-concentration curves for cefquinome with terminal half-lives of 3 and 6 h are shown in **Figure 2**. This study used time-concentration curves of the unbound fractions of cefquinome in Mueller-Hinton broth. The maximum concentrations were approximately equal to 1/2MIC to 16-fold MIC of cefquinome against *S. aureus* ATCC 25923 after three

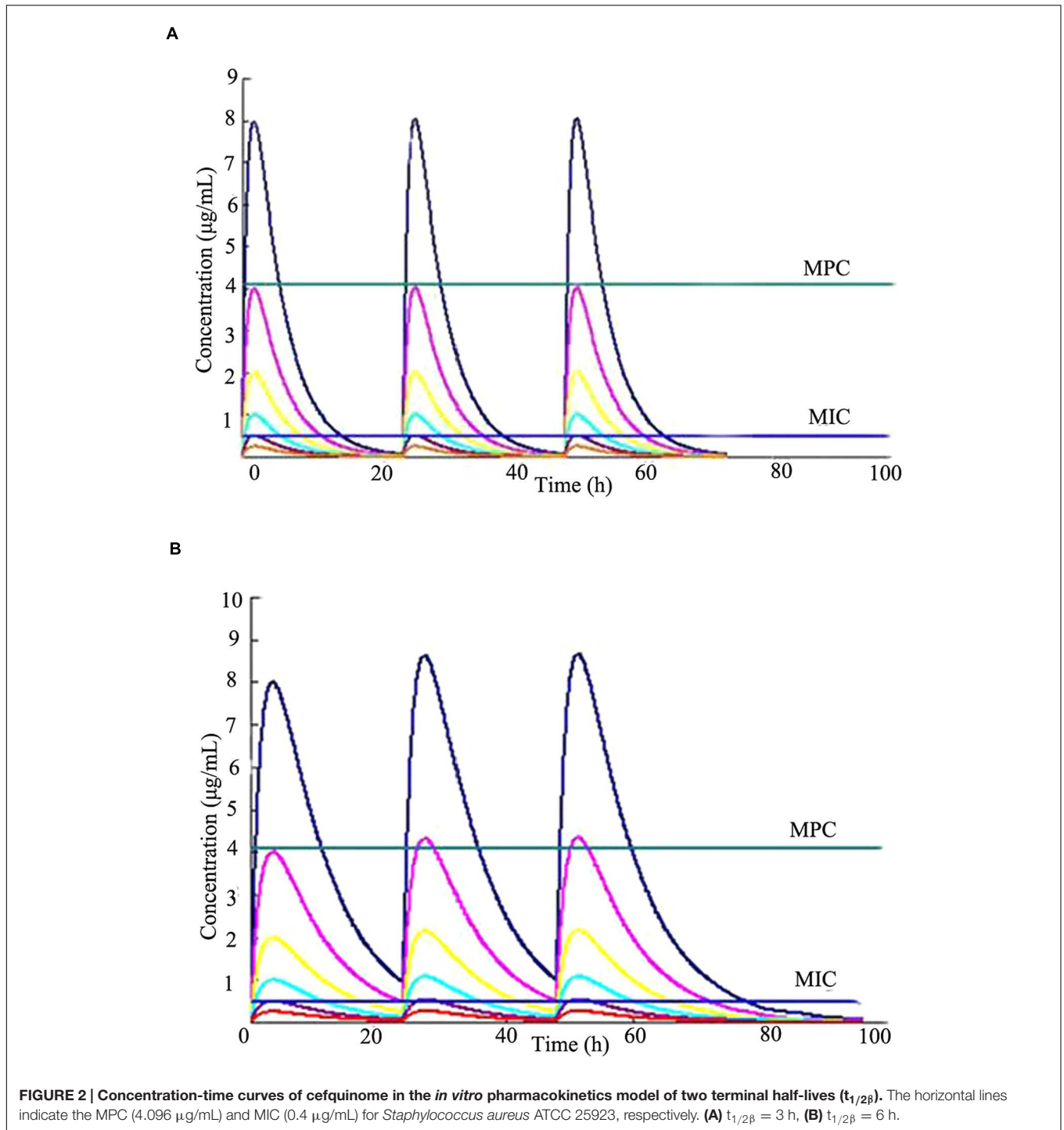

consecutive administrations. The MPC and MIC levels were also indicated in the simulated time-concentration curves.

The Bacteria Killing Curves in *In Vitro* Models

Time-killing curves of *S. aureus* ATCC 25923 in the *in vitro* model under different dosing regimens are shown in the following **Figure 3**. For a $t_{1/2\beta}$ of 3 h multiple dosages,

bacteriostatic or bactericidal action was observed when maximum cefquinome concentrations were equal to MIC or over MIC levels (dosages ranged from 0.672 to 10.767 mg). For a $t_{1/2\beta}$ of 6 h multiple dosages, continuous bactericidal action was observed when maximum cefquinome concentrations were at 4MIC, 8MIC, 16MIC (dose ranged from 2.691 to 10.767 mg), and the continuous time of bactericidal action at 16MIC was the longest among three concentrations.

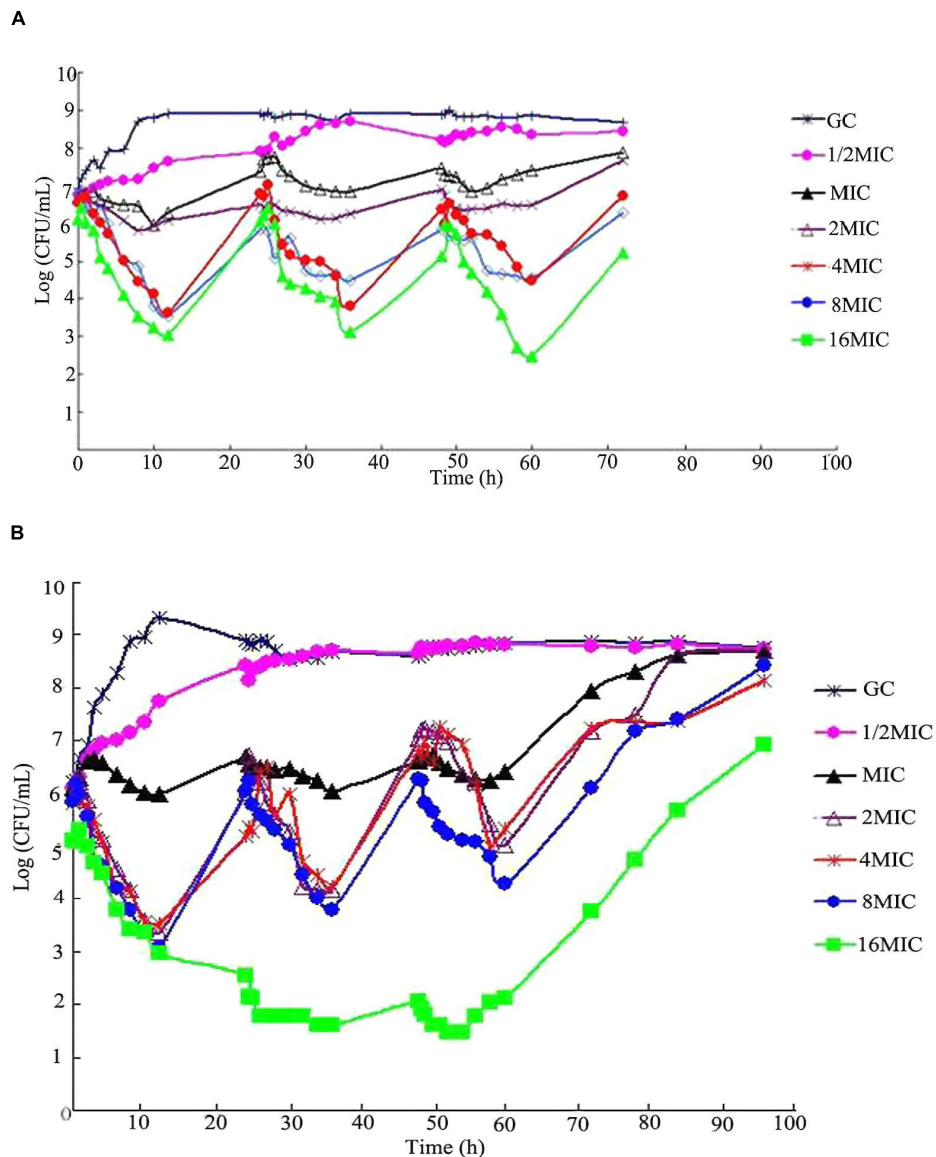

FIGURE 3 | Viable counts of *S. aureus* ATCC 25923 in time-kill assays with cefquinome in different terminal half-lives ($t_{1/2\beta}$) at cefquinome concentrations from a half to 16-fold the minimum inhibitory concentration (MIC), in comparison with a cefquinome-free control. (A) $t_{1/2\beta} = 3$ h, (B) $t_{1/2\beta} = 6$ h.

Loss of Susceptibility to Cefquinome

Compared to drug-free group, loss of susceptibility was observed in MIC, 2MIC, and 4MIC concentration groups after administrations, as shown in **Figure 4**. For multiple dosages with $t_{1/2\beta}$ of 3 h, the bacterial MICs after administration increased to 4.0, 8.0, and 1.0 $\mu\text{g/mL}$ for MIC, 2MIC, and 4MIC groups, respectively. For multiple dosages with $t_{1/2\beta}$ of 6 h, the bacterial MICs after administration increased to 2.0, 4.0, and 0.8 $\mu\text{g/mL}$ for MIC, and 2MIC, and 4MIC concentration administrations, respectively. The MIC values did not change through the whole experiment period in 8MIC and 16MIC administration groups with two different terminal half-lives.

Correlation of PK/PD Indices with Resistance Selection

Pharmacokinetic/pharmacodynamic indices, such as $\text{AUC}_{24\text{h}}/\text{MIC}$ (where $\text{AUC}_{24\text{h}}$ is the area under the drug concentration time curve in a 24 h interval) and time above the MIC, provide an empirical way to relate antimicrobial dose to favor the treatment effect of bactericidal agents. Relationships between PK/PD indices and loss of susceptibility are shown in **Table 1**. For cephalosporin, $T > \text{MIC}$ was the index most commonly associated with restricting susceptible cell growth. When $T > \text{MIC}$ attained 17.14 h or $T > \text{MIC}\%$ attained 24%, the MIC value of cefquinome against *S. aureus* increased to

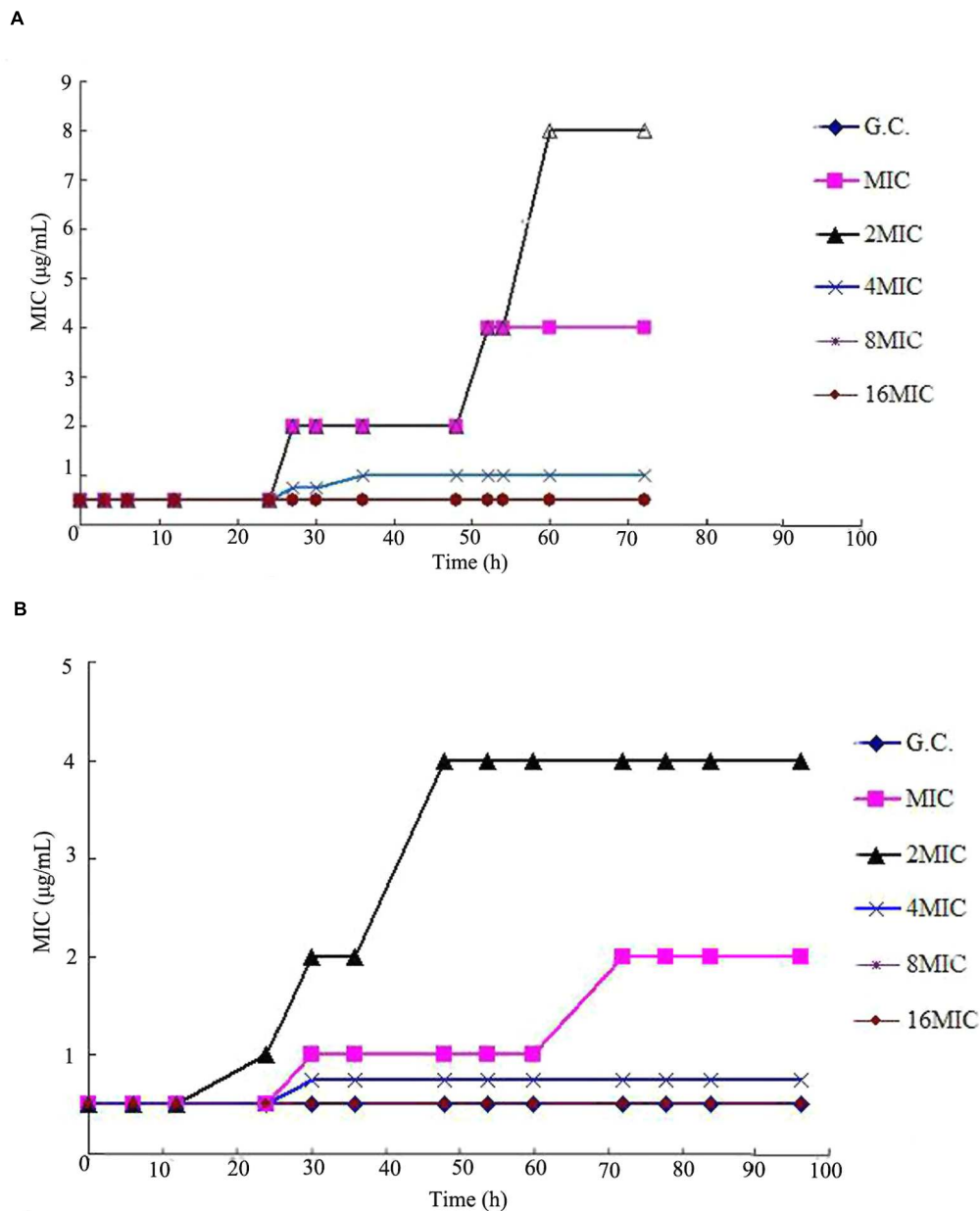

FIGURE 4 | Typical susceptibility responses of *S. aureus* ATCC 25923 observed in the *in vitro* PK/PD model simulating the pharmacokinetics of cefquinome with different terminal half-lives ($t_{1/2\beta}$). (A) $t_{1/2\beta}$ = 3 h, (B) $t_{1/2\beta}$ = 6 h.

16-fold of initial value at 72 h after multiple administrations in groups with $t_{1/2\beta}$ of 3 h. Similarly, in groups with $t_{1/2\beta}$ of 6 h, when $T > \text{MIC} = 34.28$ h or $T > \text{MIC}\% = 48\%$, the value of cefquinome MIC increased to eightfold of initial value after multiple dosages.

Other PK/PD indices also showed correlation with the selection of resistance (Table 1). When T_{MSW} and $T_{\text{MSW}}\%$ were 17.14 h and 24%, the MIC increased to 16-fold of initial value in groups with $t_{1/2\beta}$ of 3 h after multiple dosages, and the MIC increased to eightfold of initial value When T_{MSW} and $T_{\text{MSW}}\%$

were 34.28 h and 48% with $t_{1/2\beta}$ of 6 h after multiple dosages, respectively.

Correlation Analysis of MIC Increase with $T_{\text{MSW}}\%$

According to Gaussian function and regression analysis results, the bacteria was prone to develop resistance when $T_{\text{MSW}}\%$ was about 20% ($x_0 = 0.2027$) in groups with $t_{1/2\beta}$ of 3 h after multiple dosages ($R^2 = 0.9989$), and $T_{\text{MSW}}\%$ was

TABLE 1 | Pharmacokinetic/pharmacodynamic (PK/PD) indices of antimicrobial efficacy and risk of resistance selection amongst *Staphylococcus aureus* ATCC 25923 over the complete dosing interval following PK simulations of three consecutive administrations of cefquinome in $t_{1/2\beta}$ of 3 and 6 h.

$t_{1/2\beta}$ (h)	D (mg)	$\frac{AUC_{C>MIC}}{MIC}$ (h)	$\frac{AUC_{24}}{MIC}$ (h)	T > MIC (h)	T > MPC (h)	T_{MSW} (h)	$T_{MSW}\%$	T > MIC%	$\frac{MIC_{72}}{MIC_{initial}}$
3	1/2MIC	0	3.22	0	0	0	0	0	1
	MIC	6.41	6.43	8.11	0	8.11	11	11	8
	2MIC	25.89	12.89	17.14	0	17.14	24	24	16
	4MIC	64.68	25.76	26.13	0	26.13	36	36	2
	8MIC	142.34	51.52	35.13	7.81	27.32	38	49	1
	16MIC	297.75	103.07	44.14	16.82	27.32	38	61	1
6	1/2MIC	0	5.96	0	0	0	0	0	1
	MIC	12.81	11.92	16.21	0	16.21	23	23	4
	2MIC	51.77	23.89	34.28	0	34.28	48	48	8
	4MIC	129.35	47.73	52.26	0	52.26	73	73	1.5
	8MIC	284.68	95.45	70.26	15.63	54.64	76	98	1
	16MIC	595.50	190.96	88.28	33.64	54.64	76	123	1

about 40% ($x_0 = 0.4102$) in groups with $t_{1/2\beta}$ of 6 h after multiple dosages ($R^2 = 0.9986$), respectively, as shown in **Figure 5**. Those results were consistent with the data from **Table 1**.

DISCUSSION

Antimicrobial resistance has been a global problem and a great number of strategies have been proposed to slow the emergence of resistance (Stratton, 2003; Levy and Marshall, 2004). *In vivo* or *in vitro* PK/PD models have previously been applied to optimize the dosage regimen of various antibiotics in the literature (Croisier et al., 2004b; Ferran et al., 2009; Andraud et al., 2011; Gebru et al., 2012). However, PK/PD model has been renewably used to investigate relationship of bacterial resistance with AUC/MIC , C_{max}/MIC and $T > MIC$, recently. In the present study, we simulated the cefquinome pharmacokinetic profiles with different terminal half-lives using this dynamic model and tried to predict the selection of resistant *S. aureus* with some indices, such as $T > MIC$ and $T_{MSW}\%$.

It is believed that integration of drug pharmacokinetics, mutant prevention concentration is helpful in slowing the emergence of resistance. In this experiment, the MPC and MSW of cefquinome against *S. aureus* ATCC25923 were determined. The SI, ratio of MPC to MIC_{99} , is the ability of a drug to select resistant mutants (Zhao and Drlica, 2001). In other word, the bigger the SI is, the easier the drug is to induce resistance. The SI of cefquinome against *S. aureus* ATCC25923 was 10.24 in our study, which suggested that cefquinome could induce *S. aureus* resistant mutation easily and effectively.

$T > MIC$ was regarded as a promising predictor for the efficacy of cephalosporins. Previous pharmacodynamic studies have addressed separate issues around the relationships between $T > MIC$ and efficacy for cephalosporins. Craig (1995) has reviewed the data of efficacy for cephalosporins against *Enterobacteriaceae*, *streptococci* and *S. aureus* in several animal infection models and found that the time above MIC required for a bacteriostatic effect against strains of *Enterobacteriaceae*,

Streptococci were generally 60–70%, and 40–50% for *S. aureus*, respectively. In our study, the value of $T > MIC$ for maximal killing was 40~60% for cefquinome against *S. aureus* reference strain. In consistent with the widespread idea that antibacterial efficacy of β -lactams depend on $T > MIC$, the effect of cefquinome against *S. aureus* in our study exhibited similar correlation. As observed in **Figure 3**, killing curves of *S. aureus* exposed to each dose of cefquinome showed the typical pattern of time-dependent bactericidal action. The similar observation was also reported for other β -lactam drugs in previous studies (Lindecrona et al., 2000; Burgess and Hall, 2004). Considering that the $T > MIC$ was one of the most important parameters for optimal dosage regimen, $T > MIC$ was selected as a parameter to evaluate resistant mutation in this article. In the present study, the values of $T > MIC$ ranging from 8.11 to 17.14 h were dangerous zones for inducing resistant mutation in groups with $t_{1/2\beta}$ of 3 h after multiple dosages, and values ranging from 16.21 to 34.28 h were dangerous zones for inducing resistant mutation in groups with $t_{1/2\beta}$ of 6 h multiple dosages. Compared these values with previously reported study data that $T > MIC$ value ranged from 42 to 54 h for cefquinome in dairy cows (Zonca et al., 2011), the prevention of selecting resistant *S. aureus* strains seems to be achieved by the present dosage regimens approved by the European Medicines Agency (EMA) for the treatment of dairy cow mastitis.

T_{MSW} is another important parameter used for evaluating resistant mutation. A previous study conducted in a rabbit lung infection model with *Streptococcus pneumoniae* showed that the selection of resistant bacteria occurred systematically when concentrations of gatifloxacin were within the MSW (T_{MSW}) for more than 45% of the treatment duration (Croisier et al., 2004b). Another experiment in rabbits infected by *S. aureus* also showed that time in the $MSW > 33\%$ was preferable to select mutants (Cui et al., 2006). When the abilities of the indices T_{MSW} , $AUC_{24 h}/MIC$, C_{max}/MIC to predict the selection of resistant bacteria were compared, only T_{MSW} appeared to be a good predictor of the prevention of resistance (Ferran et al., 2009). In this study, T_{MSW} was also used to predict selection of

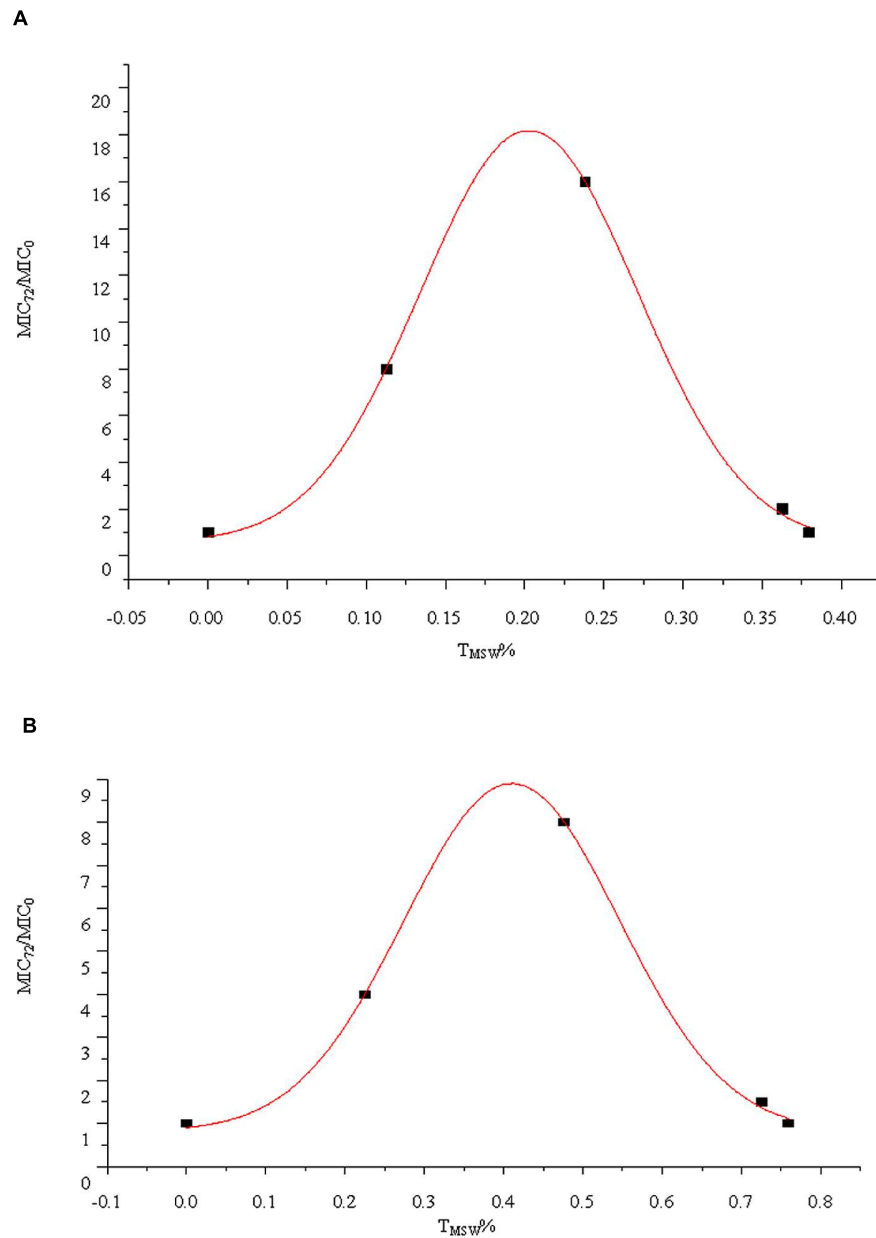

FIGURE 5 | Relationship between the $T_{MSW}\%$ and MIC_{72}/MIC_0 for *S. aureus* ATCC 25293 exposed to cefquinome in the *in vitro* model with two terminal half-lives ($t_{1/2\beta}$). (A) $t_{1/2\beta} = 3$ h, (B) $t_{1/2\beta} = 6$ h.

resistant *S. aureus* against cefquinome. It was clearly determined that when T_{MSW} was above 36% in groups with $t_{1/2\beta}$ of 3 h after multiple dosages or above 73% in groups with $t_{1/2\beta}$ of 6 h after multiple dosages, cefquinome could restrict the resistant mutation.

In the present investigation, the bacterial resistant mutation was affected by different terminal half-lives and dosages. Within the group of the same terminal half-life (3 or 6 h), the bacterial resistant mutation happened under the condition of relative low dosage (maximum concentrations were 2MIC and 4MIC). When the maximum concentration was over 8MIC, resistant mutation

was prevented. In the same dosages (maximum concentration was 2MIC or 4MIC), the $MIC_{72 h}$ increased from 8- to 16-fold in groups with $t_{1/2\beta}$ of 3 h after multiple dosages and increased from 4- to 8-fold in groups with $t_{1/2\beta}$ of 6 h after multiple dosages, respectively. Those results suggested that the bacterial resistant mutation might happen at a low concentration. In high dosages or long terminal half-lives, the drug concentrations might exceed the MPC value, the upper boundary of MSW, and the resistant mutation could be inhibited. The conclusion from this study was consistent with other similar studies (Cui et al., 2006; Ferran et al., 2009; Zhu et al., 2012).

The limitation of the study was that only one reference strain was used to simulate the efficacy of cefquinome in this *in vitro* model; however, the multi-resistance is becoming an urgent trend all over the world. It may be reasonable that more clinical isolates of *S. aureus* could be used for further study. Firsov et al. (2008) used two methicillin-resistant strains of *S. aureus*, ATCC 6538 and ATCC 43300, to study the enrichment of ciprofloxacin resistant mutation in an *in vitro* dynamic model. Liang et al. (2011), chose three clinical isolates of *S. aureus*, SA99, RN450 and RN450-A1, to analyze the enrichment of levofloxacin resistant mutation with *in vitro* dynamic model. From the results obtained in the dynamic model, more clinical isolates could be used to study resistant mutation easily based on the substantial method. Moreover, to our knowledge, evaluation of antimicrobial activity for cefquinome with different terminal half-lives is scarce. Considering the fact that cefquinome is the time-dependent drug, it is positive to study the correlation resistant mutation with different terminal half-life conditions. Another limitation of the current study was the absence of resistance mechanisms of *S. aureus* observed *in vitro*. Therefore, the pattern of *S. aureus* resistant to cefquinome, such as production of β -lactamases, alteration of drug targets, porin-mediated resistance, and/or efflux-mediated resistance, needs confirmation in the further study.

REFERENCES

- Allen, G. P., and Hankins, C. D. (2009). Evaluation of the mutant selection window for fluoroquinolones against *Neisseria gonorrhoeae*. *J. Antimicrob. Chemother.* 64, 359–363. doi: 10.1093/jac/dkp172
- Allen, G. P., Kaatz, G. W., and Rybak, M. J. (2004). In vitro activities of mutant prevention concentration-targeted concentrations of fluoroquinolones against *Staphylococcus aureus* in a pharmacodynamic model. *Int. J. Antimicrob. Agents* 24, 150–160. doi: 10.1016/j.ijantimicag.2004.03.011
- Al-Taher, A. (2010). Pharmacokinetics of cefquinome in camels. *J. Animal Vet. Adv.* 9, 848–852. doi: 10.3923/javaa.2010.848.852
- Andraud, M., Chauvin, C., Sanders, P., and Laurentie, M. (2011). Pharmacodynamic modeling of in vitro activity of marbofloxacin against *Escherichia coli* strains. *Antimicrob. Agents Chemother.* 55, 756–761. doi: 10.1128/AAC.00865-10
- Archer, G. L. (1998). *Staphylococcus aureus*: a well-armed pathogen. *Clin. Infect. Dis.* 26, 1179–1181. doi: 10.1086/520289
- Azizoglu, R. O., Lyman, R., and Anderson, K. L. (2013). Bovine *Staphylococcus aureus*: dose response to iodine and chlorhexidine and effect of iodine challenge on antibiotic susceptibility. *J. Dairy Sci.* 96, 993–999. doi: 10.3168/jds.2012-5857
- Blondeau, J., Borsos, S., Blondeau, L., Blondeau, B., and Hesje, C. (2012). Comparative minimum inhibitory and mutant prevention drug concentrations of enrofloxacin, ceftiofur, florfenicol, tilmicosin and tulathromycin against bovine clinical isolates of *Mannheimia haemolytica*. *Vet. Microbiol.* 160, 85–90. doi: 10.1016/j.vetmic.2012.05.006
- Bronner, S., Murbach, V., Peter, J.-D., Levêque, D., Elkhaili, H., Salmon, Y., et al. (2002). Ex vivo pharmacodynamics of amoxicillin-clavulanate against β -lactamase-producing *Escherichia coli* in a Yucatan miniature pig model that mimics human pharmacokinetics. *Antimicrob. Agents Chemother.* 46, 3782–3789. doi: 10.1128/AAC.46.12.3782-3789.2002
- Burgess, D. S., and Hall, R. G. II, (2004). In vitro killing of parenteral beta-lactams against standard and high inocula of extended-spectrum beta-lactamase and non-esbl producing *Klebsiella pneumoniae*. *Diagn. Microbiol. Infect. Dis.* 49, 41–46. doi: 10.1016/j.diagmicrobio.2003.11.007

CONCLUSION

The present study of resistant mutation with *S. aureus* ATCC 25923 exposed to cefquinome with two different terminal half-lives in *in vitro* dynamic models supports the MSW hypothesis and provides some useful parameters to predict the resistant mutation, especially $T > MIC$ and $T_{MSW}\%$. Further study will concentrate on more clinical isolates which could be used for verification of these results and resistance patterns of *S. aureus* resistant to cefquinome.

AUTHOR CONTRIBUTIONS

All authors listed, have made substantial, direct and intellectual contribution to the work, and approved it for publication.

ACKNOWLEDGMENTS

The authors would like to thank the financial support by the Natural Science Foundation of China (grant number 31172366) and 973 program (grant number 2013CB127200/2013CB127203).

- Cavaco, L., Abatih, E., Aarestrup, F. M., and Guardabassi, L. (2008). Selection and persistence of CTX-M-producing *Escherichia coli* in the intestinal flora of pigs treated with amoxicillin, ceftiofur, or cefquinome. *Antimicrob. Agents Chemother.* 52, 3612–3616. doi: 10.1128/AAC.00354-08
- Clinical Laboratory Standards Institute (CLSI) (2013). *Performance Standards for Antimicrobial Disk, and Dilution Susceptibility Tests for Bacteria Isolated From Animals*, Approved Standard-Fourth Edn. Wayne, PA: Clinical Laboratory Standards Institute.
- Craig, W. A. (1995). Interrelationship between pharmacokinetics and pharmacodynamics in determining dosage regimens for broad-spectrum cephalosporins. *Diagn. Microbiol. Infect. Dis.* 22, 89–96. doi: 10.1016/0732-8893(95)00053-D
- Croisier, D., Etienne, M., Bergoin, E., Charles, P.-E., Lequeu, C., Piroth, L., et al. (2004a). Mutant selection window in levofloxacin and moxifloxacin treatments of experimental pneumococcal pneumonia in a rabbit model of human therapy. *Antimicrob. Agents Chemother.* 48, 1699–1707. doi: 10.1128/AAC.48.5.1699-1707.2004
- Croisier, D., Etienne, M., Piroth, L., Bergoin, E., Lequeu, C., Portier, H., et al. (2004b). In vivo pharmacodynamic efficacy of gatifloxacin against *Streptococcus pneumoniae* in an experimental model of pneumonia: impact of the low levels of fluoroquinolone resistance on the enrichment of resistant mutants. *J. Antimicrob. Chemother.* 54, 640–647. doi: 10.1093/jac/dkh393
- Cui, J., Liu, Y., Wang, R., Tong, W., Drlica, K., and Zhao, X. (2006). The mutant selection window in rabbits infected with *Staphylococcus aureus*. *J. Infect. Dis.* 194, 1601–1608. doi: 10.1086/508752
- Dong, Y., Zhao, X., Domagala, J., and Drlica, K. (1999). Effect of fluoroquinolone on selection of resistant mutants of *Mycobacterium bovis* BCG and *Staphylococcus aureus*. *Antimicrob. Agents Chemother.* 43, 1756–1758.
- Dumka, V. K., Dinakaran, V., Ranjan, B., and Rampal, S. (2013). Comparative pharmacokinetics of cefquinome following intravenous and intramuscular administration in goats. *Small Ruminant Res.* 113, 273–277. doi: 10.1016/j.smallrumres.2013.02.010
- Ferran, A., Dupouy, V., Toutain, P.-L., and Bousquet-Mélou, A. (2007). Influence of inoculum size on the selection of resistant mutants of *Escherichia coli* in relation to mutant prevention concentrations of marbofloxacin. *Antimicrob. Agents Chemother.* 51, 4163–4166. doi: 10.1128/AAC.00156-07

- Ferran, A. A., Kesteman, A.-S., Toutain, P.-L., and Bousquet-Mélou, A. (2009). Pharmacokinetic/pharmacodynamic analysis of the influence of inoculum size on the selection of resistance in *Escherichia coli* by a quinolone in a mouse thigh bacterial infection model. *Antimicrob. Agents Chemother.* 53, 3384–3390. doi: 10.1128/AAC.01347-08
- Firsov, A. A., Lubenko, I. Y., Smirnova, M. V., Strukova, E. N., and Zinner, S. H. (2008). Enrichment of fluoroquinolone-resistant *Staphylococcus aureus*: oscillating ciprofloxacin concentrations simulated at the upper and lower portions of the mutant selection window. *Antimicrob. Agents Chemother.* 52, 1924–1928. doi: 10.1128/AAC.01371-07
- Geburu, E., Damte, D., Choi, M.-J., Lee, S.-J., Kim, Y.-H., and Park, S. C. (2012). Mutant prevention concentration and phenotypic and molecular basis of fluoroquinolone resistance in clinical isolates and in vitro-selected mutants of *Escherichia coli* from dogs. *Vet. Microbiol.* 154, 384–394. doi: 10.1016/j.vetmic.2011.07.033
- Grasso, S., Meinardi, G., De Carneri, I., and Tamassia, V. (1978). New in vitro model to study the effect of antibiotic concentration and rate of elimination on antibacterial activity. *Antimicrob. Agents Chemother.* 13, 570–576. doi: 10.1128/AAC.13.4.570
- Guardabassi, L., Schwarz, S., and Lloyd, D. H. (2004). Pet animals as reservoirs of antimicrobial-resistant bacteria review. *J. Antimicrob. Chemother.* 54, 321–332. doi: 10.1093/jac/dkh332
- Harris, S. R., Feil, E. J., Holden, M. T., Quail, M. A., Nickerson, E. K., Chantratita, N., et al. (2010). Evolution of MRSA during hospital transmission and intercontinental spread. *Science* 327, 469–474. doi: 10.1126/science.1182395
- Le Loir, Y., Baron, F., and Gautier, M. (2003). *Staphylococcus aureus* and food poisoning. *Genet. Mol. Res.* 2, 63–76.
- Levy, S. B., and Marshall, B. (2004). Antibacterial resistance worldwide: causes, challenges and responses. *Nat. Med.* 10, S122–S129. doi: 10.1038/nm1145
- Li, X., Wu, W., Su, D., Wang, Z., Jiang, H., and Shen, J. (2008). Pharmacokinetics and bioavailability of cefquinome in healthy piglets. *J. Vet. Pharmacol. Ther.* 31, 523–527. doi: 10.1111/j.1365-2885.2008.00989.x
- Liang, B., Bai, N., Cai, Y., Wang, R., Drlica, K., and Zhao, X. (2011). Mutant prevention concentration-based pharmacokinetic/pharmacodynamic indices as dosing targets for suppressing the enrichment of levofloxacin-resistant subpopulations of *Staphylococcus aureus*. *Antimicrob. Agents Chemother.* 55, 2409–2412. doi: 10.1128/AAC.00975-10
- Limbort, M., Isert, D., Klesel, N., Markus, A., Seeger, K., Seibert, G., et al. (1991). Antibacterial activities in vitro and in vivo and pharmacokinetics of cefquinome (HR 111V), a new broad-spectrum cephalosporin. *Antimicrob. Agents Chemother.* 35, 14–19. doi: 10.1128/AAC.35.1.14
- Lindecrona, R., Friis, C., and Aarestrup, F. M. (2000). The pharmacodynamic effect of amoxicillin and danofloxacin against *Salmonella typhimurium* in an in-vitro pharmacodynamic model. *Res. Vet. Sci.* 68, 261–264. doi: 10.1053/rvsc.2000.0374
- Lowy, F. D. (1998). *Staphylococcus aureus* infections. *New Engl. J. Med.* 339, 520–532. doi: 10.1056/NEJM199808203390806
- Mohammed Fayaz, A., Girilal, M., Mahdy, S. A., Somsundar, S., Venkatesan, R., and Kalaichelvan, P. (2011). Vancomycin bound biogenic gold nanoparticles: a different perspective for development of anti VRSA agents. *Process Biochem.* 46, 636–641. doi: 10.1016/j.procbio.2010.11.001
- Stratton, C. W. (2003). Dead bugs don't mutate: susceptibility issues in the emergence of bacterial resistance. *Emerg. Infect. Dis.* 9:10. doi: 10.3201/eid0901.020172
- Tauxe, R. V. (2002). Emerging foodborne pathogens. *Int. J. Food Microbiol.* 78, 31–41. doi: 10.1016/S0168-1605(02)00232-5
- Tohamy, M. (2011). Age-related intramuscular pharmacokinetics of cefquinome in sheep. *Small Ruminant Res.* 99, 72–76. doi: 10.1016/j.smallrumres.2011.03.004
- Wang, L., Yuanshu, Z., Yuhan, Z., and Yingxia, L. (2010). Mutant prevention concentrations of fluoroquinolones against *Campylobacter jejuni* isolated from chicken. *Vet. Microbiol.* 144, 409–414. doi: 10.1016/j.vetmic.2010.02.020
- Yuan, L., Sun, J., Wang, R., Sun, L., Zhu, L., Luo, X., et al. (2011). Pharmacokinetics and bioavailability of cefquinome in healthy ducks. *Am. J. Vet. Res.* 72, 122–126. doi: 10.2460/ajvr.72.1.122
- Zhao, X., and Drlica, K. (2001). Restricting the selection of antibiotic-resistant mutants: a general strategy derived from fluoroquinolone studies. *Clin. Infect. Dis.* 33, S147–S156. doi: 10.1086/321841
- Zhao, X., and Drlica, K. (2002). Restricting the selection of antibiotic-resistant mutant bacteria: measurement and potential use of the mutant selection window. *J. Infect. Dis.* 185, 561–565. doi: 10.1086/338571
- Zhu, Y.-L., Hu, L.-F., Mei, Q., Cheng, J., Liu, Y.-Y., Ye, Y., et al. (2012). Testing the mutant selection window in rabbits infected with methicillin-resistant *Staphylococcus aureus* exposed to vancomycin. *J. Antimicrob. Chemother.* 67, 2700–2706. doi: 10.1093/jac/dks280
- Zonca, A., Gallo, M., Locatelli, C., Carli, S., Moroni, P., Villa, R., et al. (2011). Cefquinome sulfate behavior after intramammary administration in healthy and infected cows. *J. Dairy Sci.* 94, 3455–3461. doi: 10.3168/jds.2010-4109

Conflict of Interest Statement: The authors declare that the research was conducted in the absence of any commercial or financial relationships that could be construed as a potential conflict of interest.

Copyright © 2016 Li, Feng, Gu, Yang, Zeng, Zhang and Ding. This is an open-access article distributed under the terms of the Creative Commons Attribution License (CC BY). The use, distribution or reproduction in other forums is permitted, provided the original author(s) or licensor are credited and that the original publication in this journal is cited, in accordance with accepted academic practice. No use, distribution or reproduction is permitted which does not comply with these terms.